

FLOOR-STANDING TYPE AIR CONDITIONER

Owner's Manual & Installation Manual

romstal

EcoVent

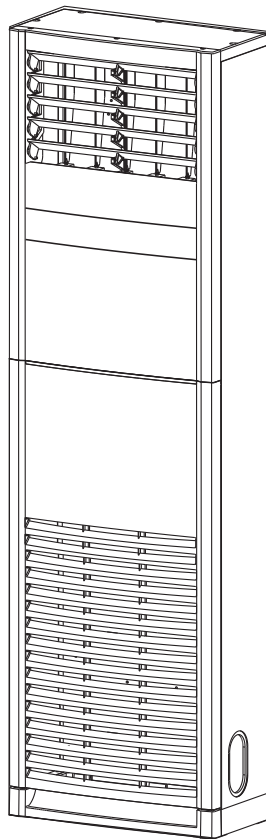

Model: 81AC0180



IMPORTANT NOTE:

Read this manual and SAFETY MANUAL(if any) carefully before installing or operating your new air conditioning unit. Make sure to save this manual for future reference.

Please check the applicable models, technical data, F-GAS(if any) and manufacturer information from the "Owner's Manual - Product Fiche " in the packaging of the outdoor unit (European Union products only) or in the packaging of the indoor unit (model dependent)

Table of Contents

Safety Precautions04

Owner's Manual

Unit Specifications and Features.....08

1. Operating temperature.....08
2. Unit parts08
3. Features.....09

Manual Operations.....09

Care and Maintenance.....15

Troubleshooting.....17

Installation Manual

Accessories	20
Installation Summary	21
Unit Parts	22
Indoor Unit Installation	23
1. Select installation location	23
2. Unfastening the operation panel and detaching the filter	24
3. Remove the fasteners from the roller	24
4. Fastening the indoor unit	24
5. Installing the rodent-proof mesh	24
6. Piping and binding	24
7. Applying the sealant putty and installing the wall hole cover	25
8. Drill wall hole for connective piping	25
9. Connect drain hose	26
Outdoor Unit Installation	27
1. Select installation location	27
2. Install drain joint	28
3. Anchor outdoor unit	28
Refrigerant Piping Connection	30
Connection Instructions –Refrigerant Piping	31
1. Cut pipes	31
2. Remove burrs	31
3. Flare pipe ends	31
4. Connect pipes	32
Wiring	33
1. Outdoor Unit Wiring	34
2. Indoor Unit Wiring	35
Air Evacuation	36
1. Evacuation Instructions	36
2. Note on Adding Refrigerant	37
Test Run	38
Packing and unpacking the unit	39

Safety Precautions

Read Safety Precautions Before Operation and Installation

Incorrect installation due to ignoring instructions can cause serious damage or injury.

The seriousness of potential damage or injuries is classified as either a **WARNING** or **CAUTION**.



WARNING

This symbol indicates the possibility of personnel injury or loss of life.



CAUTION

This symbol indicates the possibility of property damage or serious consequences.



WARNING

This appliance can be used by children aged from 8 years and above and persons with reduced physical, sensory or mental capabilities or lack of experience and knowledge if they have been given supervision or instruction concerning use of the appliance in a safe way and understand the hazards involved. Children shall not play with the appliance. Cleaning and user maintenance shall not be made by children without supervision (European Union countries).

This appliance is not intended for use by persons (including children) with reduced physical, sensory or mental capabilities, or lack of experience and knowledge, unless they have been given supervision or instruction concerning use of the appliance by a person responsible for their safety. Children should be supervised to ensure that they do not play with the appliance.



WARNINGS FOR PRODUCT USE

- If an abnormal situation arises (like a burning smell), immediately turn off the unit and disconnect the power. Call your dealer for instructions to avoid electric shock, fire or injury.
- **Do not** insert fingers, rods or other objects into the air inlet or outlet. This may cause injury, since the fan may be rotating at high speeds.
- **Do not** use flammable sprays such as hair spray, lacquer or paint near the unit. This may cause fire or combustion.
- **Do not** operate the air conditioner in places near or around combustible gases. Emitted gas may collect around the unit and cause explosion.
- **Do not** operate your air conditioner in a wet room such as a bathroom or laundry room. Too much exposure to water can cause electrical components to short circuit.
- **Do not** expose your body directly to cool air for a prolonged period of time.
- **Do not** allow children to play with the air conditioner. Children must be supervised around the unit at all times.
- If the air conditioner is used together with burners or other heating devices, thoroughly ventilate the room to avoid oxygen deficiency.
- In certain functional environments, such as kitchens, server rooms, etc., the use of specially designed air-conditioning units is highly recommended.

CLEANING AND MAINTENANCE WARNINGS

- Turn off the device and disconnect the power before cleaning. Failure to do so can cause electrical shock.
- **Do not** clean the air conditioner with excessive amounts of water.
- **Do not** clean the air conditioner with combustible cleaning agents. Combustible cleaning agents can cause fire or deformation.

CAUTION

- Turn off the air conditioner and disconnect the power if you are not going to use it for a long time.
- Turn off and unplug the unit during storms.
- Make sure that water condensation can drain unhindered from the unit.
- **Do not** operate the air conditioner with wet hands. This may cause electric shock.
- **Do not** use device for any other purpose than its intended use.
- **Do not** climb onto or place objects on top of the outdoor unit.
- **Do not** allow the air conditioner to operate for long periods of time with doors or windows open, or if the humidity is very high.

ELECTRICAL WARNINGS

- Only use the specified power cord. If the power cord is damaged, it must be replaced by the manufacturer, its service agent or similarly qualified persons in order to avoid a hazard.
- Keep power plug clean. Remove any dust or grime that accumulates on or around the plug. Dirty plugs can cause fire or electric shock.
- **Do not** pull power cord to unplug unit. Hold the plug firmly and pull it from the outlet. Pulling directly on the cord can damage it, which can lead to fire or electric shock.
- **Do not** modify the length of the power supply cord or use an extension cord to power the unit.
- **Do not** share the electrical outlet with other appliances. Improper or insufficient power supply can cause fire or electrical shock.
- The product must be properly grounded at the time of installation, or electrical shock may occur.
- For all electrical work, follow all local and national wiring standards, regulations, and the Installation Manual. Connect cables tightly, and clamp them securely to prevent external forces from damaging the terminal. Improper electrical connections can overheat and cause fire, and may also cause shock. All electrical connections must be made according to the Electrical Connection Diagram located on the panels of the indoor and outdoor units.
- All wiring must be properly arranged to ensure that the control board cover can close properly. If the control board cover is not closed properly, it can lead to corrosion and cause the connection points on the terminal to heat up, catch fire, or cause electrical shock.
- If connecting power to fixed wiring, an all-pole disconnection device which has at least 3mm clearances in all poles, and have a leakage current that may exceed 10mA, the residual current device(RCD) having a rated residual operating current not exceeding 30mA, and disconnection must be incorporated in the fixed wiring in accordance with the wiring rules.

TAKE NOTE OF FUSE SPECIFICATIONS

The air conditioner's circuit board (PCB) is designed with a fuse to provide overcurrent protection. The specifications of the fuse are printed on the circuit board ,such as : T3.15A/250VAC, T5A/250VAC, T3.15A/250VAC, T5A/250VAC, T20A/250VAC, T30A/250VAC,etc.
NOTE: For the units with R32 or R290 refrigerant , only the blast-proof ceramic fuse can be used.

**WARNINGS FOR PRODUCT INSTALLATION**

1. Installation must be performed by an authorized dealer or specialist. Defective installation can cause water leakage, electrical shock, or fire.
2. Installation must be performed according to the installation instructions. Improper installation can cause water leakage, electrical shock, or fire.
(In North America, installation must be performed in accordance with the requirement of NEC and CEC by authorized personnel only.)
3. Contact an authorized service technician for repair or maintenance of this unit. This appliance shall be installed in accordance with national wiring regulations.
4. Only use the included accessories, parts, and specified parts for installation. Using non-standard parts can cause water leakage, electrical shock, fire, and can cause the unit to fail.
5. Install the unit in a firm location that can support the unit's weight. If the chosen location cannot support the unit's weight, or the installation is not done properly, the unit may drop and cause serious injury and damage.
6. Install drainage piping according to the instructions in this manual. Improper drainage may cause water damage to your home and property.
7. For units that have an auxiliary electric heater, **do not** install the unit within 1 meter (3 feet) of any combustible materials.
8. **Do not** install the unit in a location that may be exposed to combustible gas leaks. If combustible gas accumulates around the unit, it may cause fire.
9. Do not turn on the power until all work has been completed.
10. When moving or relocating the air conditioner, consult experienced service technicians for disconnection and reinstallation of the unit.
11. How to install the appliance to its support, please read the information for details in "indoor unit installation" and "outdoor unit installation" sections .

Note about Fluorinated Gasses(Not applicable to the unit using R290 Refrigerant)

1. This air-conditioning unit contains fluorinated greenhouse gasses. For specific information on the type of gas and the amount, please refer to the relevant label on the unit itself or the "Owner's Manual - Product Fiche " in the packaging of the outdoor unit. (European Union products only).
2. Installation, service, maintenance and repair of this unit must be performed by a certified technician.
3. Product uninstallation and recycling must be performed by a certified technician.
4. For equipment that contains fluorinated greenhouse gases in quantities of 5 tonnes of CO₂ equivalent or more, but of less than 50 tonnes of CO₂ equivalent, If the system has a leak-detection system installed, it must be checked for leaks at least every 24 months.
5. When the unit is checked for leaks, proper record-keeping of all checks is strongly recommended.

**WARNING for Using R32/R290 Refrigerant**

- When flammable refrigerant are employed, appliance shall be stored in a well -ventilated area where the room size corresponds to the room area as specific for operation.
For R32 frigerant models:
Appliance shall be installed, operated and stored in a room with a floor area larger than X m² .
Appliance shall not be installed in an unventilated space, if that space is smaller than X m² .
(Please see the following form).

Amount of refrigerant to be charged (kg)	Installation height (m)	Minimum room area (m ²)	Amount of refrigerant to be charged (kg)	Installation height (m)	Minimum room area (m ²)
1.0	0.6 /1.8 /2.2	9 /1 /1	1.95	0.6 /1.8 /2.2	33 /4 /2.5
1.05	0.6 /1.8 /2.2	9.5 /1.5 /1	2.0	0.6 /1.8 /2.2	34.5 /4 /3
1.1	0.6 /1.8 /2.2	10.5 /1.5 /1	2.05	0.6 /1.8 /2.2	36 /4 /3
1.15	0.6 /1.8 /2.2	11.5 /1.5 /1	2.1	0.6 /1.8 /2.2	38 /4.5 /3
1.2	0.6 /1.8 /2.2	12.5 /1.5 /1	2.15	0.6 /1.8 /2.2	40 /4.5 /3
1.25	0.6 /1.8 /2.2	13.5 /1.5 /1	2.2	0.6 /1.8 /2.2	41.5 /5 /3.5
1.3	0.6 /1.8 /2.2	14.5 /2 /1.5	2.25	0.6 /1.8 /2.2	43.5 /5 /3.5
1.35	0.6 /1.8 /2.2	16 /2 /1.5	2.3	0.6 /1.8 /2.2	45.5 /5 /3.5
1.4	0.6 /1.8 /2.2	17 /2 /1.5	2.35	0.6 /1.8 /2.2	47.5 /5.5 /4
1.45	0.6 /1.8 /2.2	18 /2 /1.5	2.4	0.6 /1.8 /2.2	49.5 /5.5 /4
1.5	0.6 /1.8 /2.2	19.5 /2.5 /1.5	2.45	0.6 /1.8 /2.2	51.5 /6 /4
1.55	0.6 /1.8 /2.2	21 /2.5 /2	2.5	0.6 /1.8 /2.2	54 /6 /4
1.6	0.6 /1.8 /2.2	22 /2.5 /2	2.55	0.6 /1.8 /2.2	56 /6.5 /4.5
1.65	0.6 /1.8 /2.2	23.5 /3 /2	2.6	0.6 /1.8 /2.2	58 /6.5 /4.5
1.7	0.6 /1.8 /2.2	25 /3 /2	2.65	0.6 /1.8 /2.2	60.5 /7 /4.5
1.75	0.6 /1.8 /2.2	26.5 /3 /2	2.7	0.6 /1.8 /2.2	63 /7 /5
1.8	0.6 /1.8 /2.2	28 /3.5 /2.5	2.75	0.6 /1.8 /2.2	65 /7.5 /5
1.85	0.6 /1.8 /2.2	29.5 /3.5 /2.5	2.8	0.6 /1.8 /2.2	67.5 /7.5 /5
1.9	0.6 /1.8 /2.2	31 /3.5 /2.5	2.85	0.6 /1.8 /2.2	70 /8 /5.5

- Reusable mechanical connectors and flared joints are not allowed indoors. (EN Standard Requirements).
- Mechanical connectors used indoors shall have a rate of not more than 3g/year at 25% of the maximum allowable pressure. When mechanical connectors are reused indoors, sealing parts shall be renewed. When flared joints are reused indoors, the flare part shall be re-fabricated. (UL Standard Requirements)
- When mechanical connectors are reused indoors, sealing parts shall be renewed. When flared joints are reused indoors, the flare part shall be re-fabricated. (IEC Standard Requirements)
- Mechanical connectors used indoors shall comply with ISO 14903.

European Disposal Guidelines

This marking shown on the product or its literature, indicates that waste electrical and electronic equipment should not be mixed with general household waste.

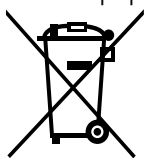

Correct Disposal of This Product
(Waste Electrical & Electronic Equipment)

This appliance contains refrigerant and other potentially hazardous materials. When disposing of this appliance, the law requires special collection and treatment. **Do not** dispose of this product as household waste or unsorted municipal waste.

When disposing of this appliance, you have the following options:

- Dispose of the appliance at designated municipal electronic waste collection facility.
- When buying a new appliance, the retailer will take back the old appliance free of charge.
- The manufacturer will take back the old appliance free of charge.
- Sell the appliance to certified scrap metal dealers.

Special notice

Disposing of this appliance in the forest or other natural surroundings endangers your health and is bad for the environment. Hazardous substances may leak into the ground water and enter the food chain.

Unit Specifications and Features

Operating temperature

When your air conditioner is used outside of the following temperature ranges, certain safety protection features may activate and cause the unit to disable.

Inverter Split Type

	COOL mode	HEAT mode	DRY mode
Room Temperature	17°C - 32°C (62°F - 90°F)	0°C - 30°C (32°F - 86°F)	10°C - 32°C (50°F - 90°F)
Outdoor Temperature	0°C - 50°C (32°F - 122°F)	-15°C - 24°C (5°F - 75°F)	0°C - 50°C (32°F - 122°F)
	-15°C - 50°C (5°F - 122°F) (For models with low temp. cooling systems.)		
	0°C - 52°C (32°F - 126°F) (For special tropical models)		0°C - 52°C (32°F - 126°F) (For special tropical models)

FOR OUTDOOR UNITS WITH AUXILIARY ELECTRIC HEATER

When outside temperature is below 0°C (32°F), we strongly recommend keeping the unit plugged in at all time to ensure smooth ongoing performance.

Fixed-speed Type

	COOL mode	HEAT mode	DRY mode
Room Temperature	17°C-32°C (62°F-90°F)	0°C-30°C (32°F-86°F)	10°C-32°C (50°F-90°F)
Outdoor Temperature	18°C-43°C (64°F-109°F)	-7°C-24°C (19°F-75°F)	11°C-43°C (52°F-109°F)
	-7°C-43°C (19°F-109°F) (For models with low-temp cooling systems)		18°C-43°C (64°F-109°F)
	18°C-52°C (64°F-126°F) (For special tropical models)		18°C-52°C (64°F-126°F) (For special tropical models)

NOTE: Room relative humidity less than 80%. If the air conditioner operates in excess of this figure, the surface of the air conditioner may attract condensation. Please sets the vertical air flow louver to its maximum angle (vertically to the floor), and set HIGH fan mode.

To further optimize the performance of your unit, do the following:

- Keep doors and windows closed.
- Limit energy usage by using TIMER ON and TIMER OFF functions.
- Do not block air inlets or outlets.
- Regularly inspect and clean air filters.

Unit parts

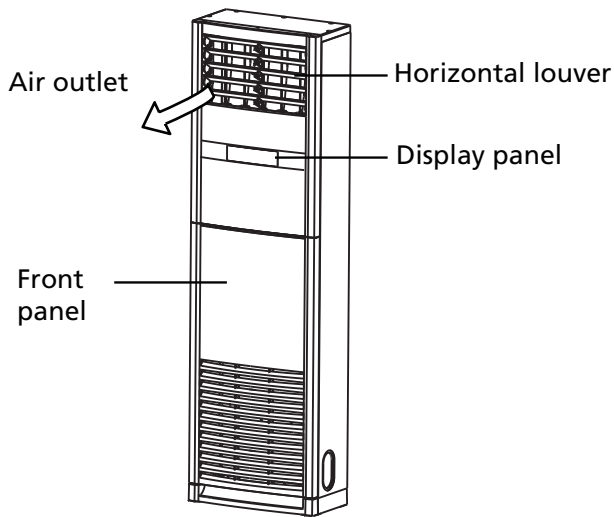

NOTE: Different models have different front panel and display window. Illustrations in this manual are for explanatory purposes. The actual shape of your indoor unit may be slightly different. The actual shape shall prevail.

Features

Default Setting

When the air conditioner restarts after a power failure, it will default to the factory settings (AUTO mode, AUTO fan, 24°C (76°F)). This may cause inconsistencies on the remote control and unit panel. Use your remote control to update the status.

Refrigerant Leak Detection System (some models)

In the event of a refrigerant leak, the LCD screen will display "EC" or "EHOC"(Model dependent).

For a detailed explanation of each function, refer to the **Remote Control Manual**.

Auto-Restart (some models)

If the unit loses power, it will automatically restart with the prior settings once power has been restored.

Louver Angle Memory Function (some models)

Some models are designed with a louver angle memory function. When the unit restarts after a power failure, the angle of the horizontal louvers will automatically return to the previous position. The angle of the horizontal louver should not be set too small as condensation may form and drip into the machine. To reset the louver, press the "AUXILIARY FUNCTION" button, which will reset the horizontal louver settings.

Manual Operations

NOTE: Not all the indicators describing below are available for the air conditioner you purchased. Please check the indoor display window of the unit you purchased.

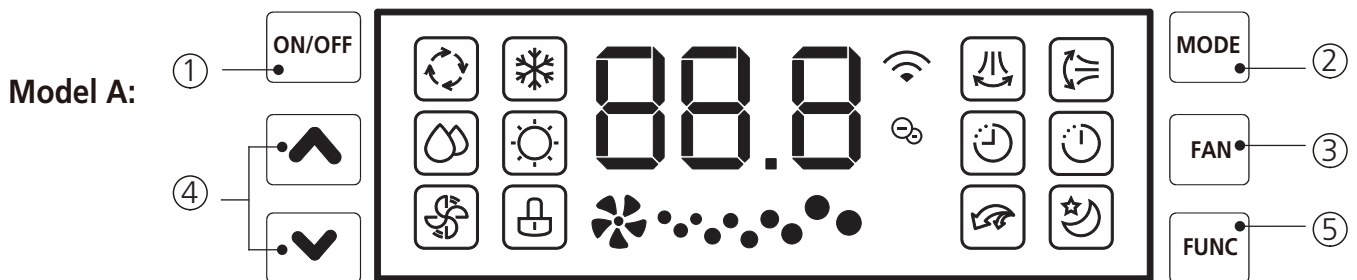

Model B:

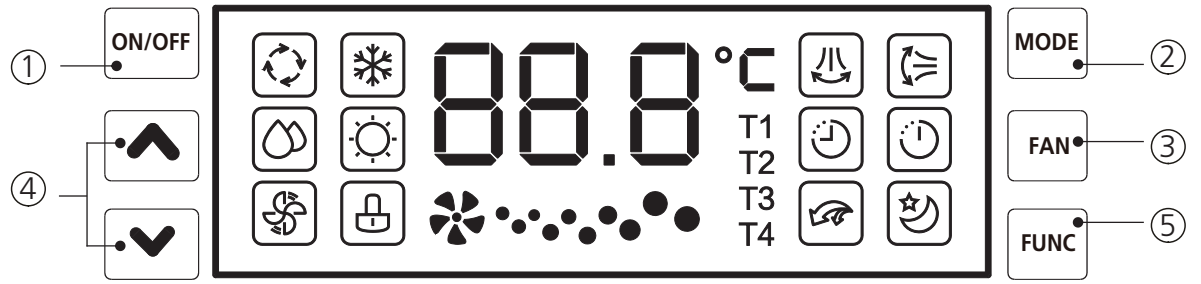

Model C:



Model D:

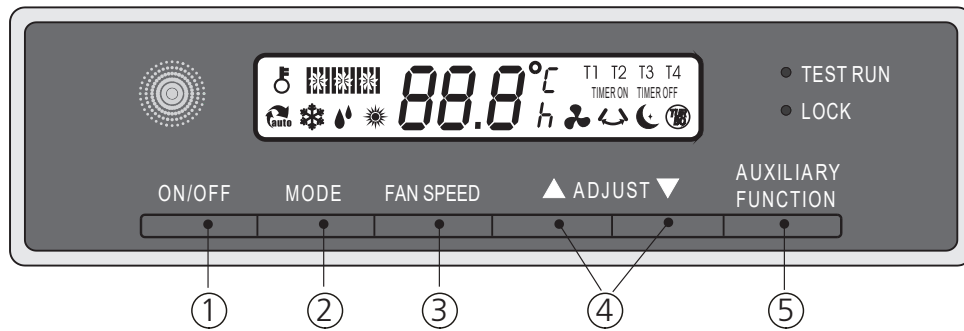

Model E:

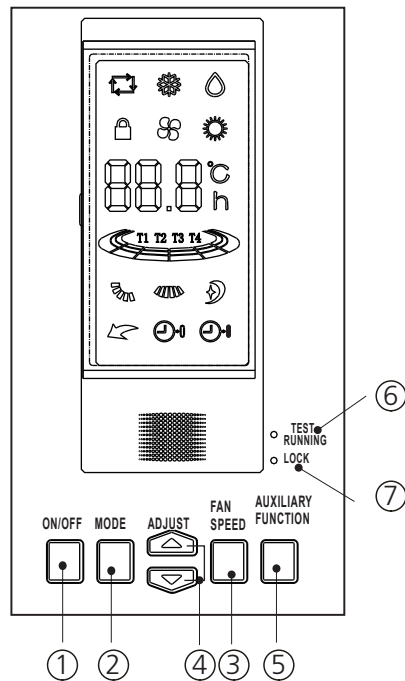

Model A/B	Model C	Model D	Model E	
				Auto operation display
				Cooling operation display
				Dry operation display
				Heating operation display
				Fan operation display
				Lock operation display
				Swing operation display
				Sleep operation display
				Turbo operation display
		TIMER ON		On timer operation display
		TIMER OFF		Off timer operation display
				Fan speed display
				Wireless control display(some units)
				Fresh feature display(some units)

NOTE: If the unit is turned off under COOL, AUTO or DRY mode with the set temperature less than 24 °C, the set temperature will be automatically set to 24 °C when you turn on the unit again. If the unit is turned off under HEAT mode with the set temperature more than 24 °C, the set temperature will be automatically set to 24 °C when you turn on the unit again (Applicable to some products only).

Operation buttons

The display panel on the indoor unit can be used to operate the unit in cases when the remote control has been misplaced or is out of batteries.

- ① **ON/OFF** button : Operation starts when this button is pressed and stops when you press the button again.
- ② **MODE** button: Press this button to select the appropriate operating mode. Each time the button is pressed, the operation mode is shifted in the direction of the arrow:



Auto: Automatically chooses the operation mode by sensing the difference between the actual ambient room temperature and the set temperature on the remote controller. The fan speed is automatically controlled.

Cool: Enables you to enjoy the cooling effect at you preferred setting temperature .

Dry: Permits dehumidifying operation . In Dry mode, you can not select Fan speed.

Heat: Permits heating operation (For cooling & heating models only).

Fan only: Permits fan operation without cooling or heating. In this case, however, the setting temperature is not displayed and you cannot adjust the set temperature.

③ **Fan speed** button: This button is used to select the desired fan speed. Each time you push the button, the fan speed is shifted in the following sequence:



NOTE: You can not select a fan speed under AUTO and DRY mode. The fan speed is automatically controlled.

Fan speed display:



The low-frequency flashing cycle of the three fan speed symbols indicate low fan or Auto fan. The high-frequency flashing cycle of the fan speed symbols indicate high fan or Auto fan. When operating manually, the first fan speed symbol displayed indicates low fan, the third symbol displayed indicates high fan, three symbols displayed simultaneously indicate Auto fan. After finishing the settings, it displays in a sequences as "First fan speed symbol→Second fan speed symbol→Third fan speed symbol". When operating with remote controller, low-frequency displaying cycle of three symbols indicates low fan or Auto fan; high-frequency displaying cycle of the symbols indicates high fan or Auto fan.

The display is separated into 3 zones. When setting the speed, the corresponding zone will illuminate.

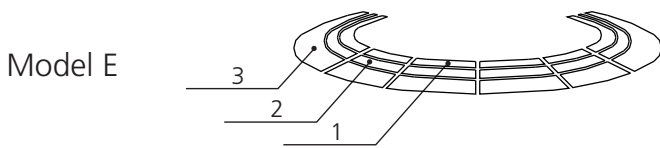
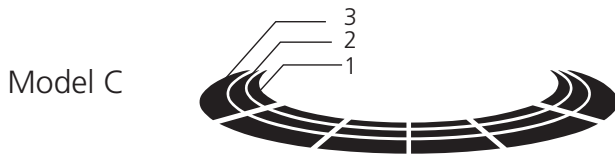

Select LOW fan speed and the first zone will illuminate;
 Select MED fan speed and the second zone will illuminate;
 Select HIGH fan speed and the third zone will illuminate;
 Select AUTO fan speed and zones 1~3 will illuminate.
 Once selected, after 2 seconds the zones will illuminate gradually based on the speed selected.

NOTE: when the indoor fan is stopped, nothing will display.

④ **ADJUST** button(Up button:“▲”,“^”, Down button:“▼”,“▼”):

1. **Temperature adjust:** Press the **Adjust Up** or **Down** button to adjust the temperature in a range of 16 °C/17°C~30°C(60 °F/62°F~86°F) or 20°C~28°C(68°F~82°F)(Model dependent).
2. **Timer adjust:** Adjust the timer on/off time under the Timer setting mode(0~24hs).
3. **Auxiliary function selection:** Select the desired auxiliary function by pressing **Adjust Up** or **Down** button.
4. Under test run operation, press **Adjust Up** or **Down** button can display the temperature of T1, T2, T3(some units) and T4(some units) , the protection or error codes. The sensor malfunction can also be detected.

⑤ **AUXILIARY FUNCTION(FUNC)** button: Use this button to select or cancel the auxiliary feature.

When the unit is on, press this button, then press the **Adjust Up** or **Down** button to select the desired feature. Each time the button is pressed, the mode is shifted in the direction of the arrow:

When press the **Adjust Up** button:

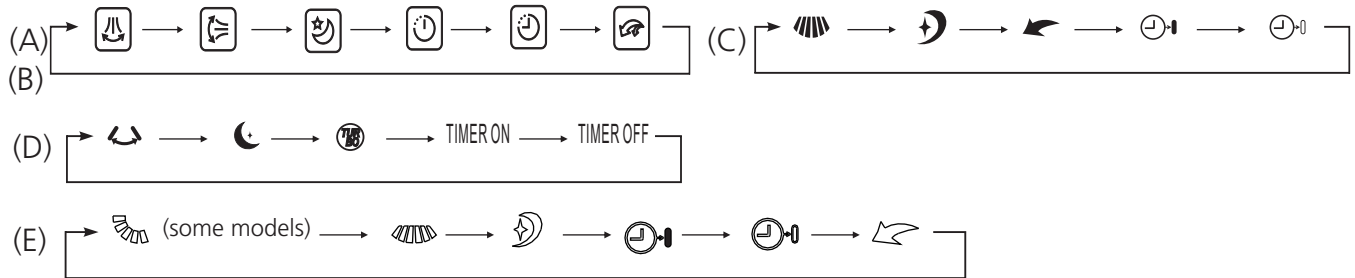

When press the **Adjust Down** button:

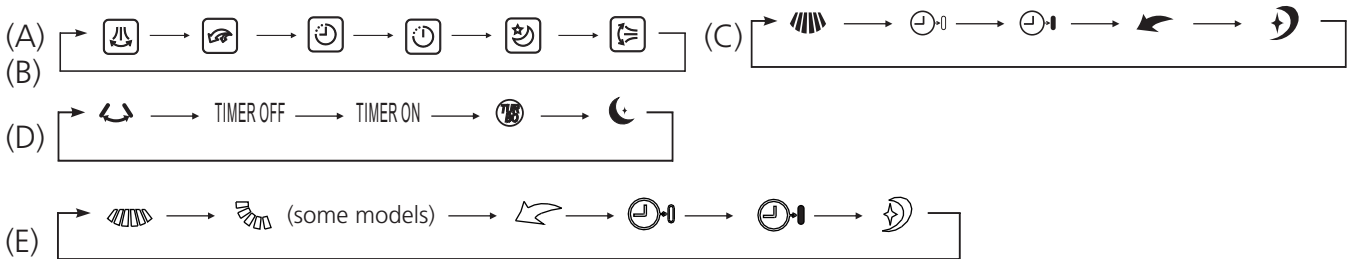

Once the desired feature is established, press the AUXILIARY FUNCTION button again to register .

If the button of AUXILIARY FUNCTION(FUNC), **Adjust Up** or **Down** is not pressed during a 10 seconds period, or the other button is pressed, or any remote operation is performed, the auxiliary function setting feature is automatically cancelled.

When the unit is off , only the TIMER ON and TIMER OFF feature can be selected.

NOTE : If the feature selected is not supported by the machine you purchased, the mode is shifted to the next feature automatically in the direction of the arrow as shown above.

⑥ **Test Run** button :

This button is specially designed for maintenance technicians.

Press this button to start test running operation, press it again to stop the operation(For Model C/D/E).

Press and hold FAN and FUNC. buttons together for one second to start/stop test running operation(For Model A & B).

The test running operation will last 30 minutes regardless of the setting temperature.

⑦ LOCK button:

Press Lock button to activate lock feature, all buttons will not response except pressing this button again to disable locking(For Model C/D/E).

Press and hold ▲ and ▼ buttons together to activate lock feature, all buttons will not response except pressing these two buttons again to disable locking(For Model A & B).

Under lock mode, if you press any other button on the display panel, the lock symbol will flash 5 seconds at 1Hz. Under Lock mode , the remote control is available.

Airflow Direction Control

Left and Right airflow (AUTO)

The Left and Right airflow can be adjusted by using the remote control or unit control panel.

Press the "AUXILIARY FUNCTION" (FUNC.) button on the unit control panel, then press the **Adjust Up** or **Down** button to select the "↶", "↷" or "↸" feature and the louvers will swing left and right.

Repeat the above procedures to stop the swing operation.

Never adjust the vertical louvers by hand.

Up and Down airflow (MANUAL) (some units)

The Up and Down airflow can only be adjusted manually. Hold the edge of the horizontal louver and move it up or down to set the desired air flow direction.

Up and Down airflow(AUTO) (some units)

The Up and Down airflow can be adjusted by using the remote control. For some units, it also can be adjust by the unit control panel.

Press the "AUXILIARY FUNCTION" (FUNC.) button on the unit control panel, then press the **Adjust Up** or **Down** button to select the "↶" or "↷" feature and the horizontal louvers will swing up and down.

Repeat the above procedures to stop the swing operation. When turn off the unit, the horizontal louvers will automatically closed to prevent dust.



WARNING

Manually moving the horizontal and vertical airflow direction louvers could damage the air conditioner(for the units with auto swing function).

NOTE:

- The starting angle of the horizontal louver should not be too small, otherwise the narrow air outlet will affect cooling or heating efficiency.
- Do not set the starting angle of the louvers too small during cooling or drying operation. Otherwise, condensation may occur on the surface of the horizontal louver and cause dew dripping.
- During the operation, if the louvers can not swing normally, shut off the unit and unplug for several minutes, then plug it again and restart the operation.
- The horizontal louver may slightly vibrate during the operation. This is normal.

Care and Maintenance

Cleaning Your Indoor Unit

BEFORE CLEANING OR MAINTENANCE

ALWAYS TURN OFF YOUR AIR CONDITIONER SYSTEM AND DISCONNECT ITS POWER SUPPLY BEFORE CLEANING OR MAINTENANCE.

CAUTION

Only use a soft, dry cloth to wipe the unit clean. If the unit is especially dirty, you can use a cloth soaked in warm water to wipe it clean.

- **Do not** use chemicals or chemically treated cloths to clean the unit.
- **Do not** use benzene, paint thinner, polishing powder or other solvents to clean the unit. They can cause the plastic surface to crack or deform.
- **Do not** use water hotter than 40°C (104°F) to clean the front panel. This can cause the panel to deform or become discolored.

A clogged air conditioner can reduce the cooling efficiency of your unit, and can also be bad for your health. Make sure to clean the filter once every two weeks.

WARNING: DO NOT REMOVE OR CLEAN THE FILTER BY YOURSELF

Removing and cleaning the filter can be dangerous.

NOTE: In households with animals, you will have to periodically wipe down the grille to prevent animal hair blocking airflow.

If the air filter becomes clogged, the performance will decrease and electricity will be wasted.

CAUTION

- Do not use water to clean the inside of the indoor unit. This can destroy insulation and cause electrical shock.
- Do not expose filter to direct sunlight when drying. This can shrink the filter.
- Any maintenance and cleaning of outdoor unit should be performed by an authorized dealer or a licensed service provider.
- Any unit repairs should be performed by an authorized dealer or a licensed service provider.

WARNING

- If the refrigerant leaks, turn off the air conditioner and any combustible heating devices, ventilate the room and call your dealer immediately. Refrigerant is both toxic and flammable. **DO NOT** use the air conditioner until the leak is repaired.
- When the air conditioner is installed in a small room, measures must be taken to prevent the refrigerant concentration from exceeding the safety limit in the event of refrigerant leakage. Concentrated refrigerant causes a severe health and safety threat.

Refrigerant Leak Detection System (some models)

- In the event of a refrigerant leak, the LCD screen will display "EC" .

Maintenance – Long Periods of Non-Use

If you plan not to use your air conditioner for an extended period of time, do the following:

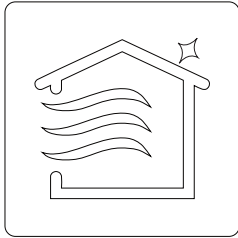

Turn on FAN function until unit dries out completely

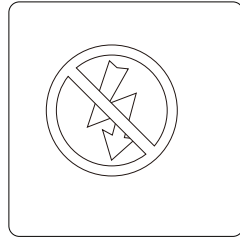

Turn off the unit and disconnect the power

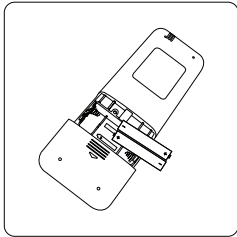

Remove batteries from remote control

Maintenance – Pre-Season Inspection

After long periods of non-use, or before periods of frequent use, do the following:

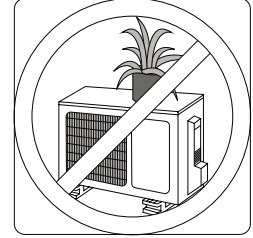
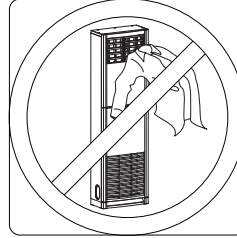

Make sure nothing is blocking all air inlets and outlets



Check for leaks

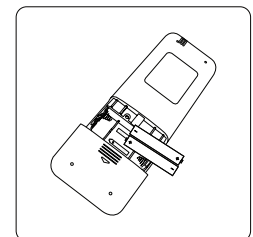

Replace batteries

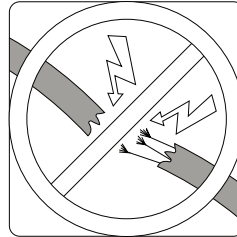

Check for damaged wires

Troubleshooting

SAFETY PRECAUTIONS

If any of the following conditions occurs, turn off your unit immediately!

- The power cord is damaged or abnormally warm
- You smell a burning odor
- The unit emits loud or abnormal sounds
- A power fuse blows or the circuit breaker frequently trips
- Water or other objects fall into or out of the unit

DO NOT ATTEMPT TO FIX THESE YOURSELF! CONTACT AN AUTHORIZED SERVICE PROVIDER IMMEDIATELY!

Common Issues

The following problems are not a malfunction and in most situations will not require repairs.

Issue	Possible Causes
Unit does not turn on when pressing ON/OFF button	The unit has a 3-minute protection feature that prevents the unit from overloading. The unit cannot be restarted within three minutes of being turned off.
The unit changes from COOL mode to FAN mode	The unit changes its setting to prevent frost from forming on the unit. Once the temperature increases, the unit will start operating again.
	The set temperature has been reached, at which point the unit turns off the compressor. The unit will resume operating when the temperature fluctuates again.
The indoor unit emits white mist	In humid regions, a large temperature difference between the room's air and the conditioned air can cause white mist.
Both the indoor and outdoor units emit white mist	When the unit restarts in HEAT mode after defrosting, white mist may be emitted due to moisture generated from the defrosting process.
The indoor unit makes noises	A squeaking sound is heard when the system is OFF or in COOL mode. The noise is also heard when the drain pump (optional) is in operation.
	A squeaking sound may occur after running the unit in HEAT mode due to expansion and contraction of the unit's plastic parts.
Both the indoor unit and outdoor unit make noises	A low hissing sound may occur during operation. This is normal and is caused by refrigerant gas flowing through both the indoor and outdoor units.
	A low hissing sound may be heard when the system starts, has just stopped running or is defrosting. This noise is normal and is caused by the refrigerant gas stopping or changing direction.

Issue	Possible Causes
The outdoor unit makes noises	The unit will make different sounds based on its current operating mode.
Dust is emitted from either the indoor or outdoor unit	The unit may accumulate dust during extended periods of non-use, which will be emitted when the unit is turned on. This can be mitigated by covering the unit during long periods of inactivity.
The unit emits a bad odor	The unit may absorb odors from the environment (such as furniture, cooking, cigarettes, etc.) which will be emitted during operations.
	The unit's filters have become moldy and should be cleaned.
The fan of the outdoor unit does not operate	During operation, the fan speed is controlled to optimize product operation.

NOTE: If problem persists, contact a local dealer or your nearest customer service center. Provide them with a detailed description of the unit malfunction as well as your model number.

Troubleshooting

When troubles occur, please check the following points before contacting a repair company.















Problem	Possible Causes	Solution
Poor Cooling Performance	Temperature setting may be higher than ambient room temperature	Lower the temperature setting
	The heat exchanger on the indoor or outdoor unit is dirty	Clean the affected heat exchanger
	The air filter is dirty	Remove the filter and clean it according to instructions
	The air inlet or outlet of either unit is blocked	Turn the unit off, remove the obstruction and turn it back on
	Doors and windows are open	Make sure that all doors and windows are closed while operating the unit
	Excessive heat is generated by sunlight	Close windows and curtains during periods of high heat or bright sunshine
	Too many sources of heat in the room (people, computers, electronics, etc.)	Reduce amount of heat sources
	Low refrigerant due to leak or long-term use	Check for leaks, re-seal if necessary and top off refrigerant

Problem	Possible Causes	Solution
The unit is not working	Power failure	Wait for the power to be restored
	The power is turned off	Turn on the power
	The fuse is burned out	Replace the fuse
	Remote control batteries are dead	Replace batteries
	The Unit's 3-minute protection has been activated	Wait three minutes after restarting the unit
	Timer is activated	Turn timer off
The unit starts and stops frequently	There's too much or too little refrigerant in the system	Check for leaks and recharge the system with refrigerant.
	Incompressible gas or moisture has entered the system.	Evacuate and recharge the system with refrigerant
	System circuit is blocked	Determine which circuit is blocked and replace the malfunctioning piece of equipment
	The compressor is broken	Replace the compressor
	The voltage is too high or too low	Install a manostat to regulate the voltage
Poor heating performance	The outdoor temperature is extremely low	Use auxiliary heating device
	Cold air is entering through doors and windows	Make sure that all doors and windows are closed during use
	Low refrigerant due to leak or long-term use	Check for leaks, re-seal if necessary and top off refrigerant
Indicator lamps continue flashing	<p>The unit may stop operation or continue to run safely. If the indicator lamps continue to flash or error codes appear, wait for about 10 minutes. The problem may resolve itself.</p> <p>If not, disconnect the power, then connect it again. Turn the unit on. If the problem persists, disconnect the power and contact your nearest customer service center.</p>	
<p>Error code appears and begins with the letters as the following in the window display of indoor unit:</p> <ul style="list-style-type: none"> • E(x), P(x), F(x) • EH(xx), EL(xx), EC(xx) • PH(xx), PL(xx), PC(xx) 		

NOTE: If your problem persists after performing the checks and diagnostics above, turn off your unit immediately and contact an authorized service center.

Accessories

The air conditioning system comes with the following accessories. Use all of the installation parts and accessories to install the air conditioner. Improper installation may result in water leakage, electrical shock and fire, or cause the equipment to fail. The items are not included with the air conditioner must be purchased separately.

Name of Accessories	Q'ty(pc)	Shape	Name of Accessories	Q'ty(pc)	Shape
Manual	2-3		Remote controller	1	
Drain joint (some models)	1		Battery	2	
Seal (some models)	1		Remote controller holder(optional)	1	
Drain hose (some models)	1		Fixing screw for remote controller holder(optional)	2	
Band (some models)	2		Flat washers (some models)	2	
Soundproof/insulation sheath (some models)	2		Connection cables (some models)	1	
Wall hole cover	1		Putty (some models)	1	
Rodent-proof mesh	1		Refrigerant Pipe (optional)	1	
Self-tapping screw A (some models) Used to fix the cord clamp of indoor unit after wire connection	3		Copper nut (some models) Used to make the connective pipes between indoor and outdoor units.	2	
Throttle (some models)	1				

Accessories

Name	Shape	Quantity(PC)
Connecting pipe assembly	Liquid side	Φ 6.35(1/4in)
		Φ 9.52(3/8in)
		Φ 12.7(1/2in)
	Gas side	Φ 9.52(3/8in)
		Φ 12.7(1/2in)
		Φ 16(5/8in)
		Φ 19(3/4in)
		Φ 22(7/8in)
Parts you must purchase separately. Consult the dealer about the proper pipe size of the unit you purchased.		

Installation Summary - Indoor Unit

INSTALLATION ORDER

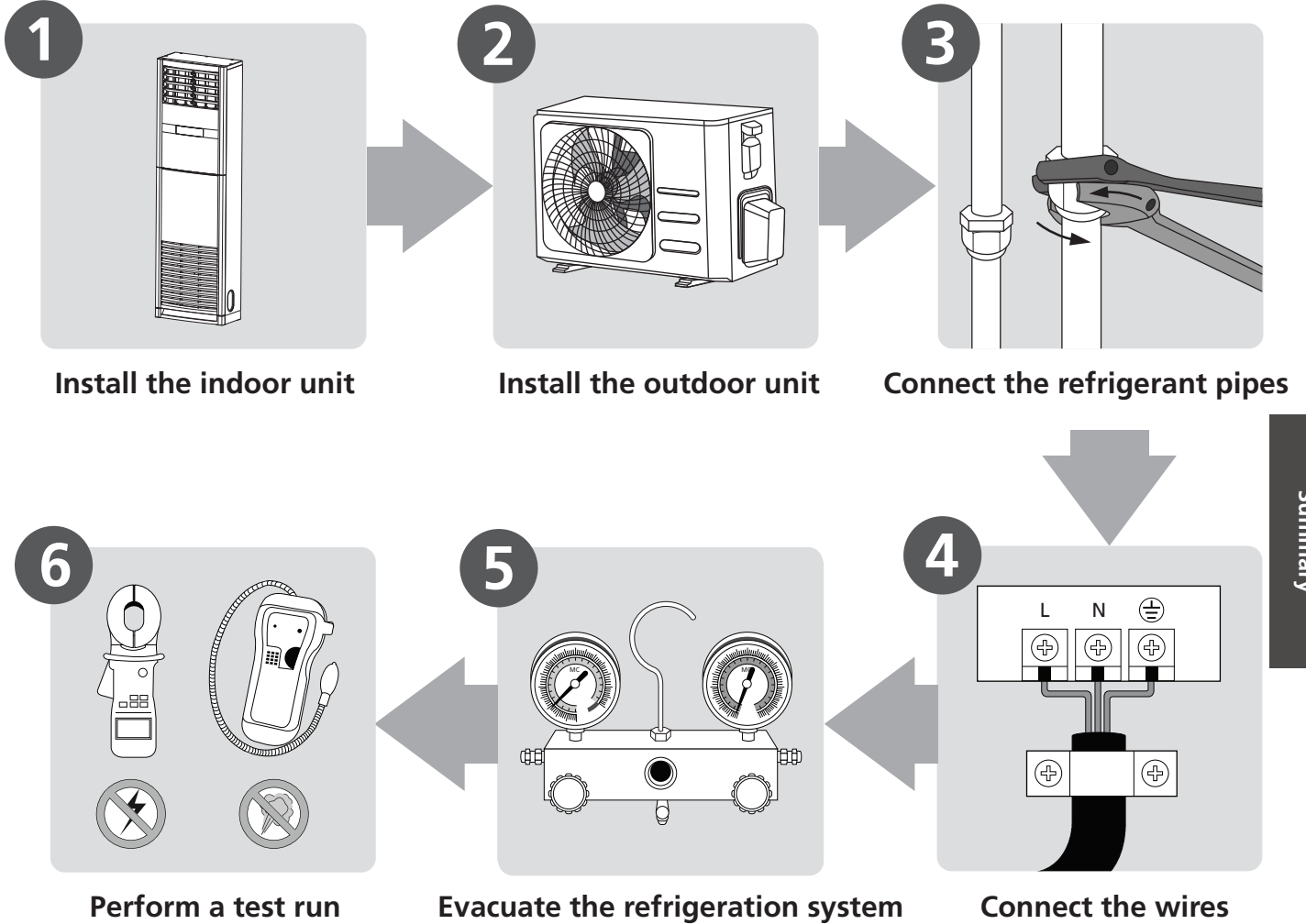

Unit Parts

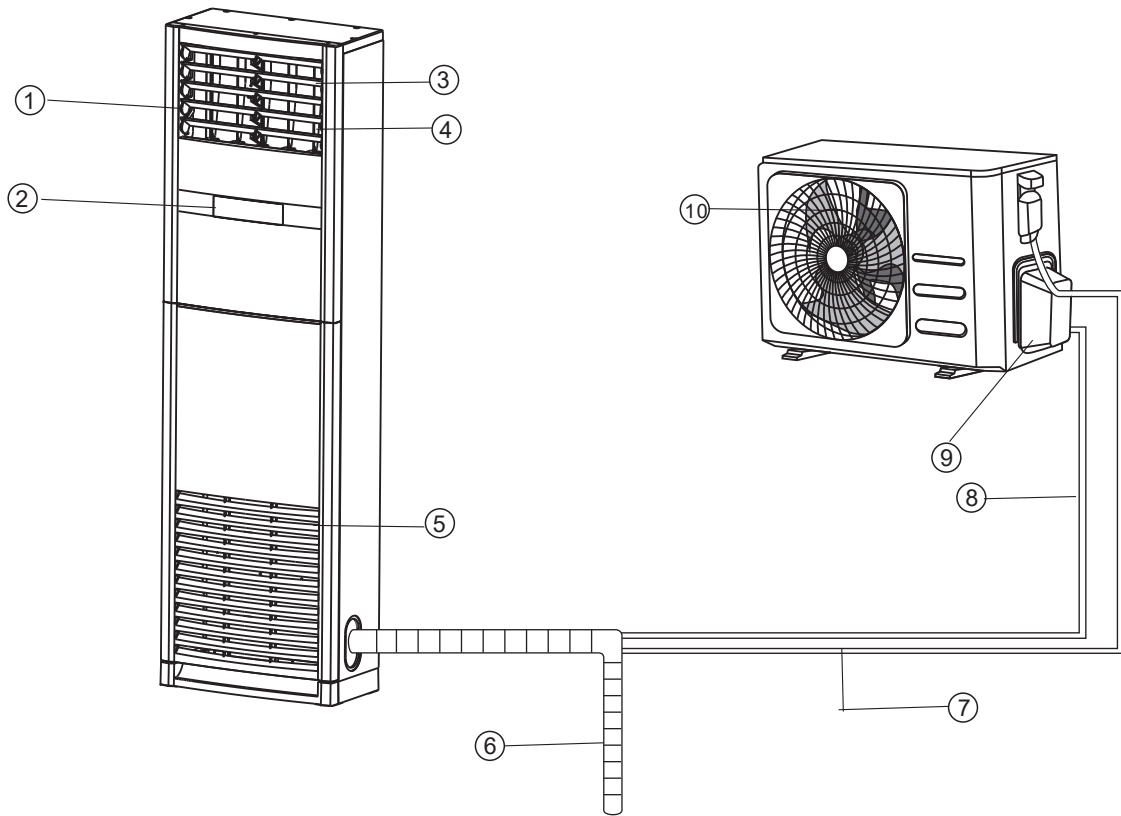

Indoor unit

- ① Air outlet
- ② Operation panel
- ③ Horizontal airflow control louver
- ④ Vertical airflow control louver
- ⑤ Air inlet

Outdoor unit

- ⑥ Drain pipe, vent pipe
- ⑦ Connection cable
- ⑧ Connection pipe
- ⑨ Refrigerant pipe port
- ⑩ Air outlet

NOTE ON ILLUSTRATIONS

Illustrations in this manual are for explanatory purposes. The actual shape of your indoor unit may be slightly different. The actual shape shall prevail.

Indoor Unit Installation

Installation Instructions – Indoor unit

PRIOR TO INSTALLATION

Before installing the indoor unit, refer to the label on the product box to make sure that the model number of the indoor unit matches the model number of the outdoor unit.

Step 1: Select installation location

Before installing the indoor unit, you must choose an appropriate location. The following are standards that will help you choose an appropriate location for the unit.

Proper installation locations meet the following standards:

- ☑ Good air circulation
- ☑ Convenient drainage
- ☑ Noise from the unit will not disturb other people
- ☑ Firm and solid—the location will not vibrate
- ☑ Strong enough to support the weight of the unit
- ☑ A location at least one meter from all other electrical devices (e.g., TV, radio, computer)

DO NOT install unit in the following locations:

- ⊘ Near any source of heat, steam, or combustible gas
- ⊘ Near flammable items such as curtains or clothing
- ⊘ Near any obstacle that might block air circulation
- ⊘ Near the doorway
- ⊘ In a location subject to direct sunlight

NOTE ABOUT WALL HOLE:

If there is no fixed refrigerant piping:

While choosing a location, be aware that you should leave ample room for a wall hole (see **Drill wall hole for connective piping** step) for the signal cable and refrigerant piping that connect the indoor and outdoor units. The default position for all piping is the right side of the indoor unit (while facing the unit). However, the unit can accommodate piping to both the left and right.

Refer to the following diagram to ensure proper distance from walls and ceiling:

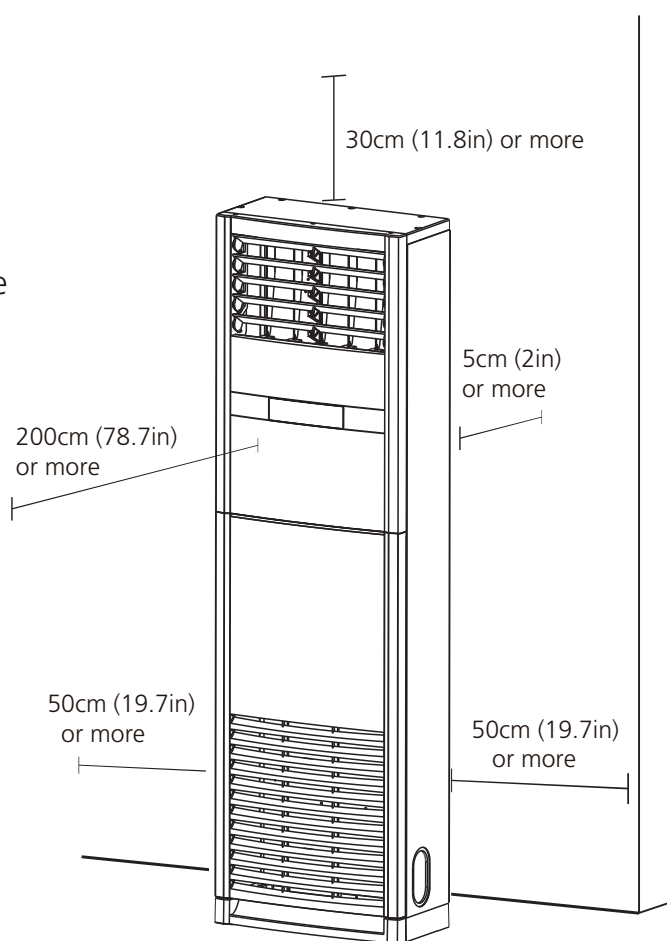

Indoor Unit
Installation

Step 2: Unfastening the operation panel and detaching the filter

1. Open the packaging and take out the indoor unit. Remove the protective tape and any components.
2. Please take off the lower front panel before connecting the pipes/wires. Pull down the two knobs on the grille, take off the two screws, then the air-inlet grille goes free.

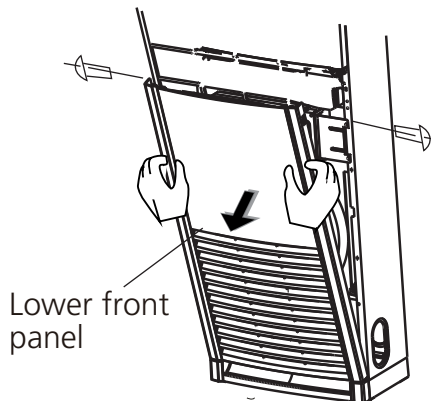

3. Remove all of the accessories placed inside the bottom cavity of the indoor unit.
4. Check that all of the accessories match those found on the "Installation Diagrams and Accessories" as shown on the previous page.

Step 3. Remove the fasteners from the roller (only found on selected models)

1. Check to see whether the roller on the indoor unit has any fasteners holding it in place and tear off the notice sticker.
2. Remove the fasteners from the roller according to the directions on the sticker.

Step 4. Fastening the indoor unit (to prevent it from falling down)

1. Measure the position of the holes for installation.
2. Insert the M8 bolts into the unit while it is on the floor (the amount of bolts used depends on the number of holes on the unit's chassis).
3. Lift up the indoor unit so that the installation holes cover the bolts, then fasten the nuts onto the bolts and tighten them.

⚠ CAUTION

If further support is needed to prevent the unit from falling down, a protective wedge can be installed. The installation procedure for this wedge is as follows:

- Take out the protective wedge and measure the correct size.
- Use the self-tapping screws to fasten the protective wedge to the top cover of the indoor unit.
- Fasten the other end of the wedge tightly to the wall using the self-tapping screws.

Step 5. Installing the rodent-proof mesh

1. Remove the metal rodent-proof mesh from the piping found on the unit by gently tapping on it.
2. Use a knife to cut a small hole by following the markings on the ratproof board.
3. Insert the ratproof board into the unit and hold it in place tightly.

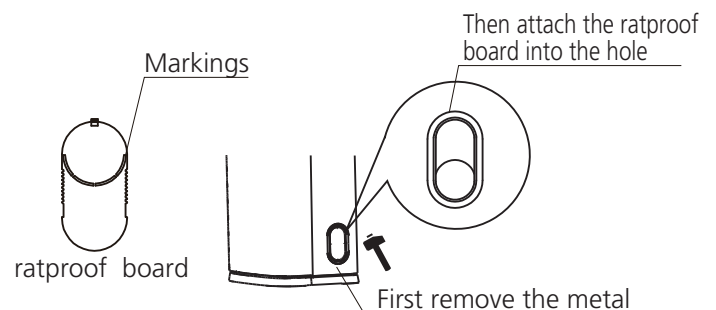

Step 6. Piping and binding

1. Lay the connecting piping flat on the ground. Place the drainage hose, refrigerant pipe, and all electrical wiring (making sure that both ends are arranged correctly) next to the piping.
2. Using the drainage hose as a guide, measure and adjust the length of the low voltage wiring, high voltage wiring, any other electrical wiring, and refrigerant pipe. Use cable ties to initially fasten them in place.

3. Arrange the piping so that the drainage hose is on the bottom, the connecting piping is in the middle, and the electrical wiring is at the top.
4. Use adhesive vinyl tape to begin binding the piping together. Start binding the tape at the bottom end of the drainage hose, and make sure that the connectors are secured tightly.
Pipe/wire-hole positions on both sides

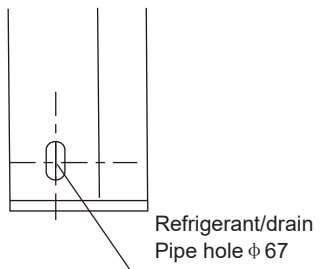

Pipe/wire-hole position on the bottom

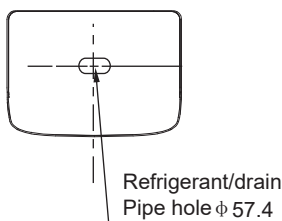

Pipe/wire-hole position on back side

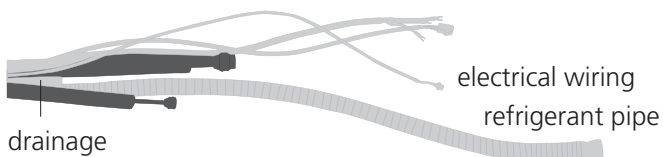
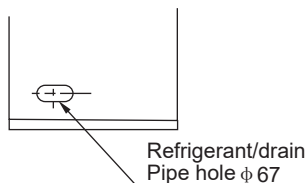

⚠ CAUTION

The electrical wiring, drainage hose, and refrigerant pipe must exit the binding in a suitable place. All binding must be mutually connected, evenly applied, and aesthetically pleasing.

NOTE

- Only models with a ventilation function contain ventilation ducting.
- The amount and type of electrical wiring used may vary according to the specific model.
- The ends of the ventilation ducting and electrical wiring are different, please check carefully before starting to bind.

Step 7: Applying the sealant putty and installing the wall hole cover

1. Tidy up the already bound piping.
2. Evenly apply the sealant putty to the gaps between the piping and the wall, then press on the putty firmly.
3. Pull the wall hole cover apart to open it. After fastening tightly to the piping, push it into the hole in the wall to securely fasten it to the wall and complete the installation.

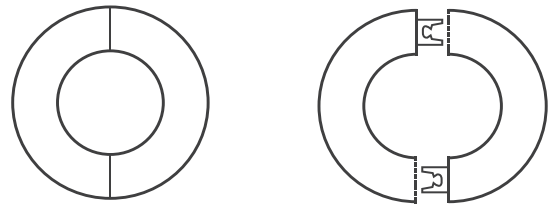

Step 8: Drill wall hole for connective piping

1. Determine the location of the wall hole based on the location of the outdoor unit.
2. Using a 65-mm (2.5") core drill, drill a hole in the wall. Make sure that the hole is drilled at a slight downward angle, so that the outdoor end of the hole is lower than the indoor end by about 1cm (0.4"). This will ensure proper water drainage. Place the protective wall cuff in the hole. This protects the edges of the hole and will help seal it when you finish the installation process.

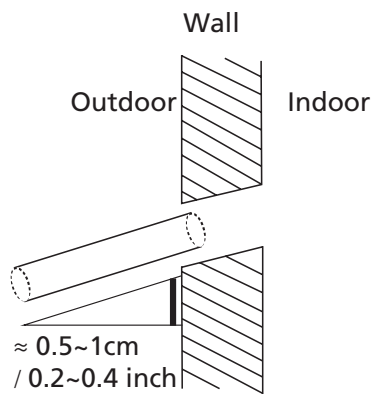

- Place the protective wall cuff in the hole. This protects the edges of the hole and will help seal it when you finish the installation process.

⚠ CAUTION

When drilling the wall hole, make sure to avoid wires, plumbing, and other sensitive components.

Step 9: Connect drain hose

The drainpipe is used to drain water away from the unit. Improper installation may cause unit and property damage.

⚠ CAUTION

- Insulate all piping to prevent condensation, which could lead to water damage.
- If the drainpipe is bent or installed incorrectly, water may leak and cause a malfunction of the water-level switch.
- In HEAT mode, the outdoor unit will discharge water. Ensure that the drain hose is placed in an appropriate area to avoid water damage and slippage due to frozen drain water.
- DO NOT** pull the drainpipe forcefully as this could cause it to disconnect.

NOTE ON PURCHASING PIPES

This installation requires a polyethylene tube (outside diameter = 3.7-3.9cm, inside diameter = 3.2cm), which can be obtained at your local hardware store or from your dealer.

Indoor Drainpipe Installation

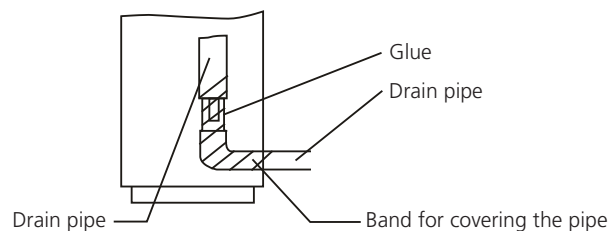

- Make sure the drain pipe is connected to the outdoor side downward.
- The hard polyvinyl chloride(PVC)plastic pipe (external diameter 26 mm) sold in the market is suitable for the attached soft drain pipe.
- Please connect the Soft Drain Pipe with the Drain Pipe, then fix it with band; if you have to connect the Drain Pipe indoors, to avoid condensing caused by air intake, you must cover the pipe with heat-insulation material (polyethylene with Specific Gravity of 0.03, at least 9 mm in thickness), and use Glue Band to fix it.
- After the Drain Pipe has been connected, please check if the water drains out of the pipe efficiently and has no leakage.
- Refrigerant Pipe and Drain Pipe should be heat-insulated to avoid condensing and water-dropping later on.
- Pass the drain hose through the wall hole. Make sure the water drains to a safe location where it will not cause water damage or a slipping hazard.

NOTE: The drainpipe outlet should be at least 5cm (1.9") above the ground. If it touches the ground, the unit may become blocked and malfunction. If you discharge the water directly into a sewer, make sure that the drain has a U or S pipe to catch odors that might otherwise come back into the house.

Outdoor Unit Installation

Install the unit by following local codes and regulations, there may be differ slightly between different regions.

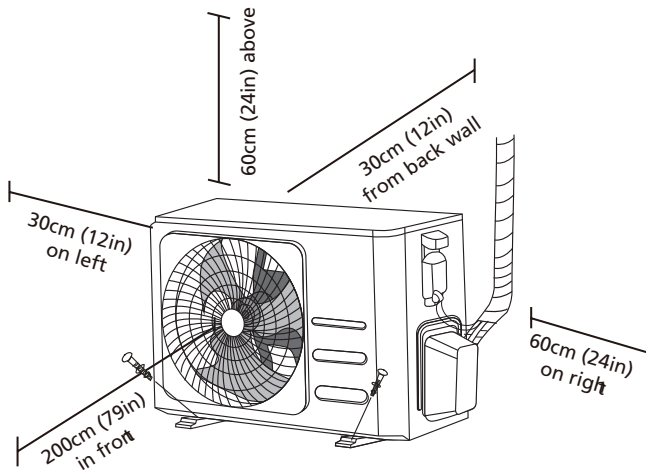

Installation Instructions – Outdoor unit

Step 1: Select installation location

Before installing the outdoor unit, you must choose an appropriate location. The following are standards that will help you choose an appropriate location for the unit.

Proper installation locations meet the following standards:

- ☑ Meets all spatial requirements shown in Installation Space Requirements above.
- ☑ Good air circulation and ventilation
- ☑ Firm and solid—the location can support the unit and will not vibrate
- ☑ Noise from the unit will not disturb others
- ☑ Protected from prolonged periods of direct sunlight or rain
- ☑ Where snowfall is anticipated, take appropriate measures to prevent ice buildup and coil damage.

DO NOT install unit in the following locations:

- ⊘ Near an obstacle that will block air inlets and outlets
- ⊘ Near a public street, crowded areas, or where noise from the unit will disturb others
- ⊘ Near animals or plants that will be harmed by hot air discharge
- ⊘ Near any source of combustible gas
- ⊘ In a location that is exposed to large amounts of dust
- ⊘ In a location exposed to a excessive amounts of salty air

SPECIAL CONSIDERATIONS FOR EXTREME WEATHER

If the unit is exposed to heavy wind:

Install unit so that air outlet fan is at a 90° angle to the direction of the wind. If needed, build a barrier in front of the unit to protect it from extremely heavy winds. See Figures below.

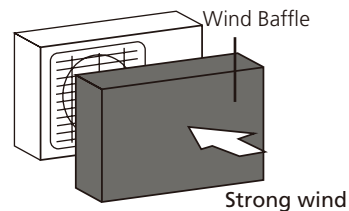
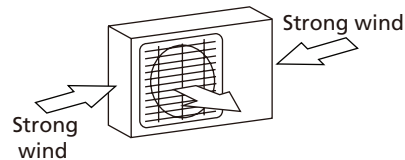

If the unit is frequently exposed to heavy rain or snow:

Build a shelter above the unit to protect it from the rain or snow. Be careful not to obstruct air flow around the unit.

If the unit is frequently exposed to salty air (seaside):

Use outdoor unit that is specially designed to resist corrosion.

Step 2: Install drain joint (Heat pump unit only)

Before bolting the outdoor unit in place, you must install the drain joint at the bottom of the unit. Note that there are two different types of drain joints depending on the type of outdoor unit.

If the drain joint comes with a rubber seal (see **Fig. A**), do the following:

1. Fit the rubber seal on the end of the drain joint that will connect to the outdoor unit.
2. Insert the drain joint into the hole in the base pan of the unit.
3. Rotate the drain joint 90° until it clicks in place facing the front of the unit.
4. Connect a drain hose extension (not included) to the drain joint to redirect water from the unit during heating mode.

If the drain joint doesn't come with a rubber seal (see **Fig. B**), do the following:

1. Insert the drain joint into the hole in the base pan of the unit. The drain joint will click in place.
2. Connect a drain hose extension (not included) to the drain joint to redirect water from the unit during heating mode.

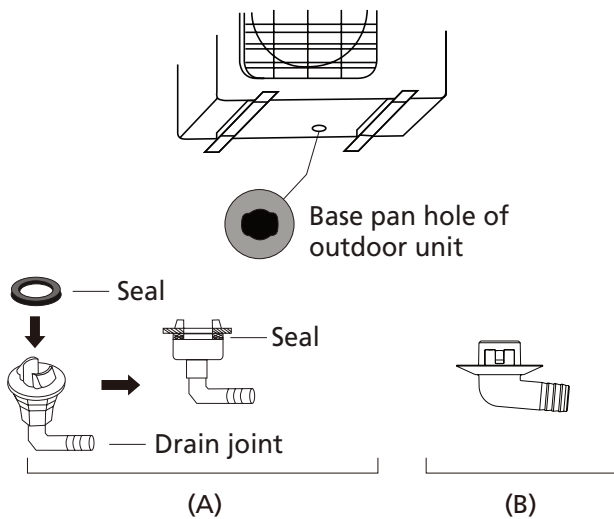

! IN COLD CLIMATES

In cold climates, make sure that the drain hose is as vertical as possible to ensure swift water drainage. If water drains too slowly, it can freeze in the hose and flood the unit.

Step 3: Anchor outdoor unit

The mounting dimensions vary among different outdoor units.

The fixing bolt head diameter should be more than 12mm.

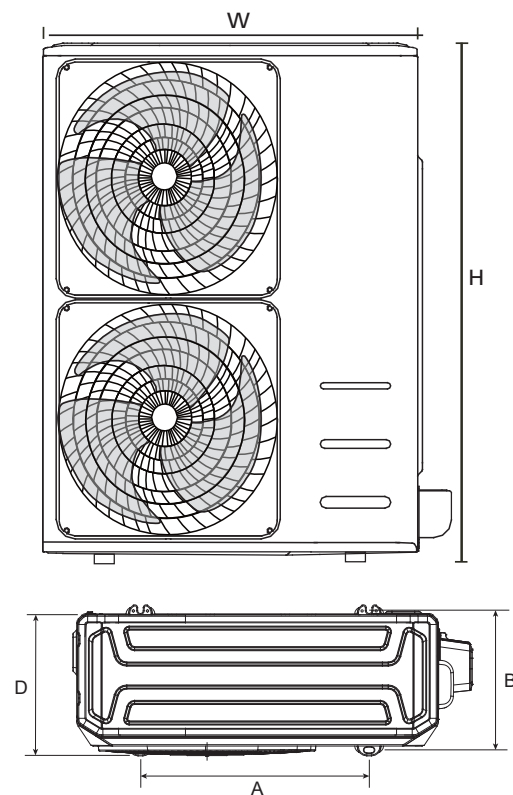

Outdoor Unit Dimension (mm/inch)	Mounting Dimension (mm/inch)	
	A	B
952x1333x415(37.5x52.5x16.3)	634(24.9)	404(15.9)
900x1170x350(35.4x46.1x13.8)	590(23.2)	378(14.9)

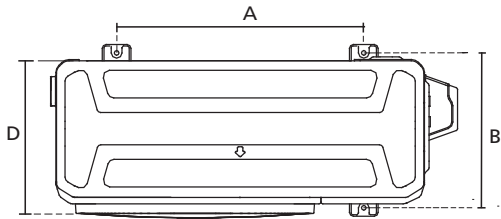
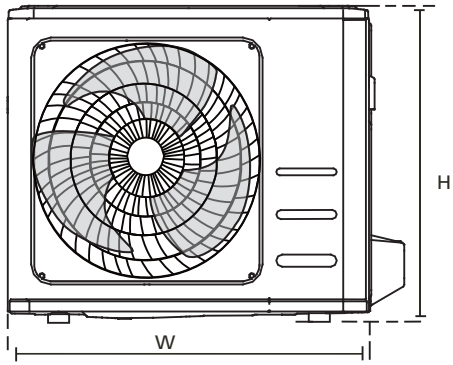

Outdoor Unit Dimension (mm/inch)	Mounting Dimension (mm/inch)	
	W x H x D	A
700x550x270 (27.5x 21.6x 10.6)	450 (17.7)	260 (10.2)
770x555x300 (30.3x 21.8x 11.8)	487 (19.2)	298 (11.7)
800x554x333 (31.5x 21.8x 13.1)	514 (20.2)	340 (13.4)
805x554x330 (31.7x 21.8x 12.9)	511 (20.1)	317 (12.5)
845x702x363 (33.3x 27.6x 14.3)	540 (21.3)	350 (13.8)
890x673x342 (35.0x 26.5x 13.5)	663 (26.1)	354 (13.9)
946x810x420 (37.2x 31.9x 16.5)	673 (26.5)	403 (15.9)
946x810x410 (37.2x 31.9x 16.1)	673 (26.5)	403 (15.9)

Rows of series installation

The relations between H, A and L are as follows

	L	A
$L \leq H$	$L \leq 1/2H$	25 cm / 9.8" or more
	$1/2H < L \leq H$	30 cm / 11.8" or more
$L > H$	Can not be installed	

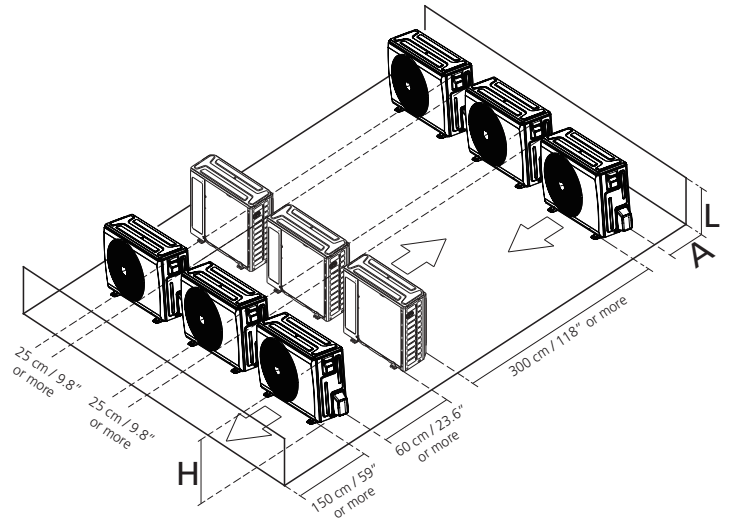

Refrigerant Piping Connection

When connecting refrigerant piping, **do not** let substances or gases other than the specified refrigerant enter the unit. The presence of other gases or substances will lower the unit's capacity, and can cause abnormally high pressure in the refrigeration cycle. This can cause explosion and injury.

Note on Pipe Length

Please check the elevation difference between the indoor unit and the outdoor unit, the length of the refrigerant pipe, and the curved places (bend) of the pipe as following:

Elevation difference: no more than 10 M

Pipe length: no more than 20 M

Bends: no more than 5 places

A minimum pipe run of 3 metres is required to minimise vibration & excessive noise.

⚠ CAUTION

Oil traps

If oil flows back into the outdoor unit's compressor, this might cause liquid compression or deterioration of oil return. Oil traps in the rising gas piping can prevent this.

An oil trap should be installed every 6m(20ft) of vertical suction line riser.

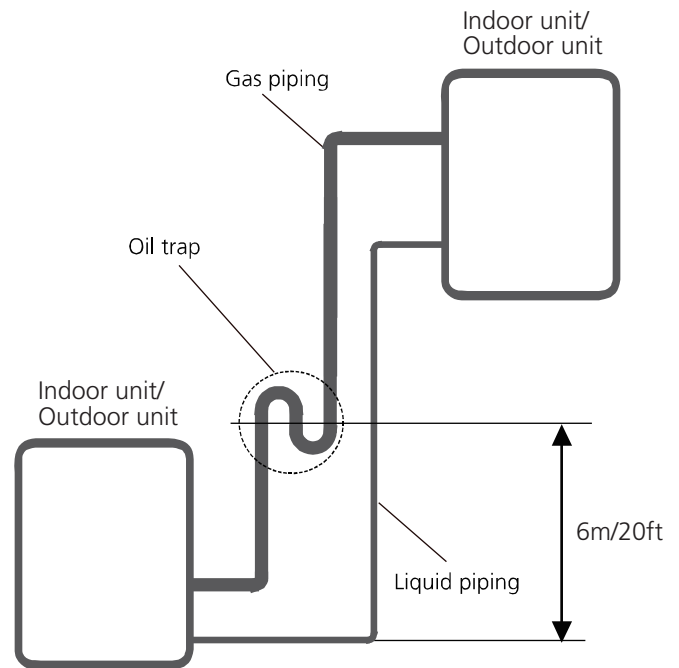

Connection Instructions – Refrigerant Piping

Step 1: Cut pipes

When preparing refrigerant pipes, take extra care to cut and flare them properly. This will ensure efficient operation and minimize the need for future maintenance.

1. Measure the distance between the indoor and outdoor units.
2. Using a pipe cutter, cut the pipe a little longer than the measured distance.
3. Make sure that the pipe is cut at a perfect 90° angle.

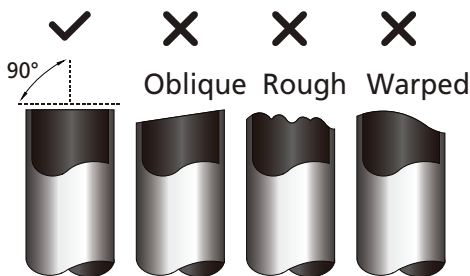

DO NOT DEFORM PIPE WHILE CUTTING

Be extra careful not to damage, dent, or deform the pipe while cutting. This will drastically reduce the heating efficiency of the unit.

Step 2: Remove burrs

Burrs can affect the air-tight seal of refrigerant piping connection. They must be completely removed.

1. Hold the pipe at a downward angle to prevent burrs from falling into the pipe.
2. Using a reamer or deburring tool, remove all burrs from the cut section of the pipe.

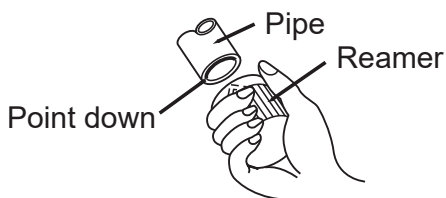

Step 3: Flare pipe ends

Proper flaring is essential to achieve an airtight seal.

1. After removing burrs from cut pipe, seal the ends with PVC tape to prevent foreign materials from entering the pipe.
2. Sheath the pipe with insulating material.
3. Place flare nuts on both ends of pipe. Make sure they are facing in the right direction, because you can't put them on or change their direction after flaring.

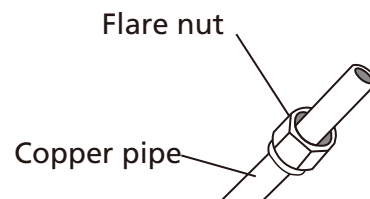

4. Remove PVC tape from ends of pipe when ready to perform flaring work.
5. Clamp flare form on the end of the pipe. The end of the pipe must extend beyond the flare form.

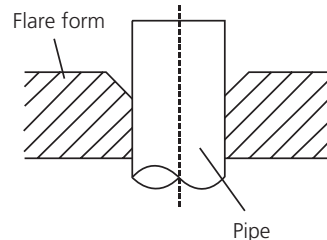

6. Place flaring tool onto the form.
7. Turn the handle of the flaring tool clockwise until the pipe is fully flared. Flare the pipe in accordance with the dimensions shown in table .
8. Remove the flaring tool and flare form, then inspect the end of the pipe for cracks and even flaring.

PIPING EXTENSION BEYOND FLARE FORM

Pipe gauge	Tightening torque	Flare dimension (A) (Unit: mm/Inch)		Flare shape
		Min.	Max.	
Ø 6.35 (Ø 1/4")	18-20 N.m (180-200kgf.cm)	8.4/0.33	8.7/0.34	
Ø 9.52 (Ø 3/8")	32-39 N.m (320-390kgf.cm)	13.2/0.52	13.5/0.53	
Ø 12.7 (Ø 1/2")	49-59 N.m (490-590kgf.cm)	16.2/0.64	16.5/0.65	
Ø 16 (Ø 5/8")	57-71 N.m (570-710kgf.cm)	19.2/0.76	19.7/0.78	
Ø 19 (Ø 3/4")	67-101 N.m (670-1010kgf.cm)	23.2/0.91	23.7/0.93	
Ø 22 (Ø 7/8")	85-110 N.m (850-1100kgf.cm)	26.4/1.04	26.9/1.06	

Refrigerant piping Connection

Step 4: Connect pipes

Connect the copper pipes to the indoor unit first, then connect it to the outdoor unit. You should first connect the low-pressure pipe, then the high-pressure pipe.

1. When connecting the flare nuts, apply a thin coat of refrigeration oil to the flared ends of the pipes.
2. Align the center of the two pipes that you will connect.

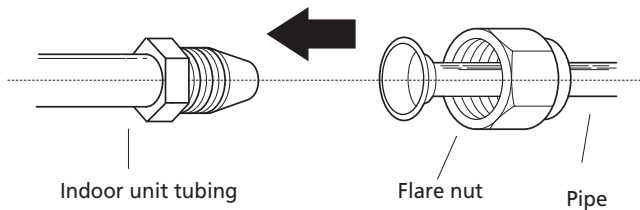

3. Tighten the flare nut as tightly as possible by hand.
4. Using a spanner, grip the nut on the unit tubing.
5. While firmly gripping the nut, use a torque wrench to tighten the flare nut according to the torque values in table .

NOTE: Use both a spanner and a torque wrench when connecting or disconnecting pipes to/from the unit.

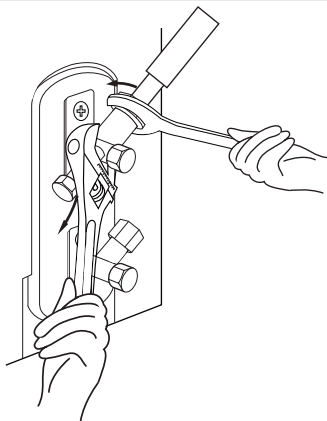

⚠ CAUTION

- Ensure to wrap insulation around the piping. Direct contact with the bare piping may result in burns or frostbite.
- Make sure the pipe is properly connected. Over tightening may damage the bell mouth and under tightening may lead to leakage.

NOTES ON MINIMUM BEND RADIUS

Carefully bend the tubing in the middle according to the diagram below. **DO NOT** bend the tubing more than 90° or more than 3 times.

Bend the pipe with thumb

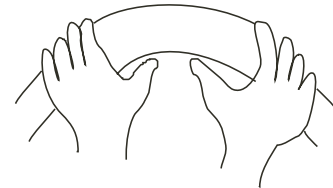

min-radius 10cm (3.9")

6. After connecting the copper pipes to the indoor unit, wrap the power cable, signal cable and the piping together with binding tape.

NOTE: DO NOT intertwine signal cable with other wires. While bundling these items together, do not intertwine or cross the signal cable with any other wiring.

7. Thread this pipeline through the wall and connect it to the outdoor unit.
8. Insulate all the piping, including the valves of the outdoor unit.
9. Open the stop valves of the outdoor unit to start the flow of the refrigerant between the indoor and outdoor unit.

⚠ CAUTION

Check to make sure there is no refrigerant leak after completing the installation work. If there is a refrigerant leak, ventilate the area immediately and evacuate the system (refer to the Air Evacuation section of this manual).

Wiring

BEFORE PERFORMING ANY ELECTRICAL WORK, READ THESE REGULATIONS

1. All wiring must comply with local and national electrical codes, regulations and must be installed by a licensed electrician.
2. All electrical connections must be made according to the Electrical Connection Diagram located on the panels of the indoor and outdoor units.
3. If there is a serious safety issue with the power supply, stop work immediately. Explain your reasoning to the client, and refuse to install the unit until the safety issue is properly resolved.
4. Power voltage should be within 90-110% of rated voltage. Insufficient power supply can cause malfunction, electrical shock, or fire.
5. If connecting power to fixed wiring, install a surge protector and main power switch with a capacity of 1.5 times the maximum current of the unit.
6. If connecting power to fixed wiring, a switch or circuit breaker that disconnects all poles and has a contact separation of at least 1/8in (3mm) must be incorporated in the fixed wiring. The qualified technician must use an approved circuit breaker or switch.
7. Only connect the unit to an individual branch circuit outlet. Do not connect another appliance to that outlet.
8. Make sure to properly ground the air conditioner.
9. Every wire must be firmly connected. Loose wiring can cause the terminal to overheat, resulting in product malfunction and possible fire. Do not let wires touch or rest against refrigerant tubing, the compressor, or any moving parts within the unit.
10. If the unit has an auxiliary electric heater, it must be installed at least 1 meter (40in) away from any combustible materials.
11. To avoid getting an electric shock, never touch the electrical components soon after the power supply has been turned off.
12. After turning off the power, always wait 10 minutes or more before you touch the electrical components.
13. Make sure that you do not cross your electrical wiring with your signal wiring. This may cause distortion and interference.
14. The unit must be connected to the main outlet. Normally, the power supply must have an impedance of 32 ohms.
15. No other equipment should be connected to the same power circuit.
16. Connect the outdoor wires before connecting the indoor wires.

WARNING

BEFORE PERFORMING ANY ELECTRICAL OR WIRING WORK, TURN OFF THE MAIN POWER TO THE SYSTEM.

NOTE ON AIR SWITCH

When the maximum current of the air conditioner is more than 16A, an air switch or leakage protection switch with protective device shall be used (purchased separately).

When the maximum current of the air conditioner is less than 16A, the power cord of air conditioner shall be equipped with plug (purchased separately).

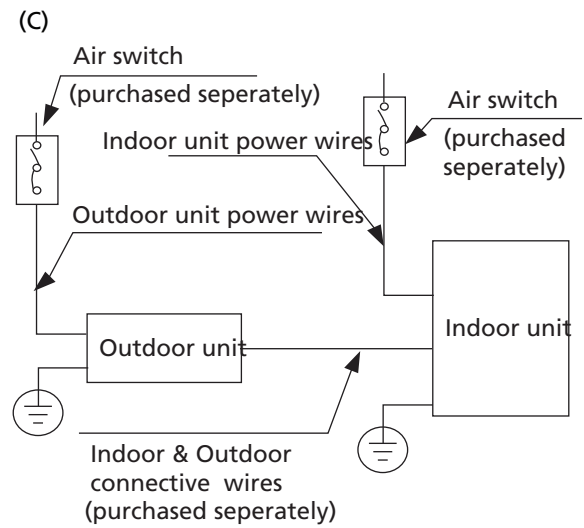
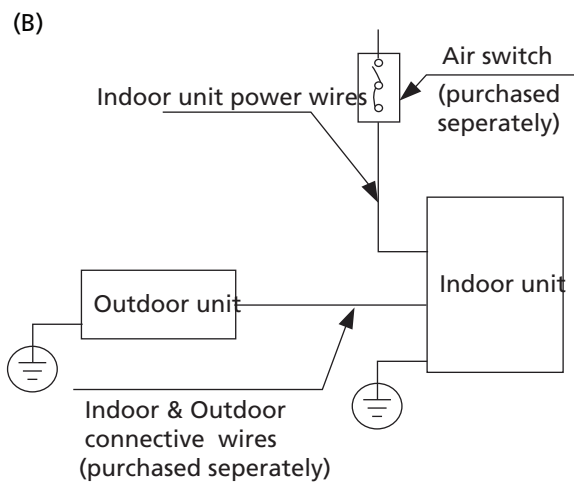
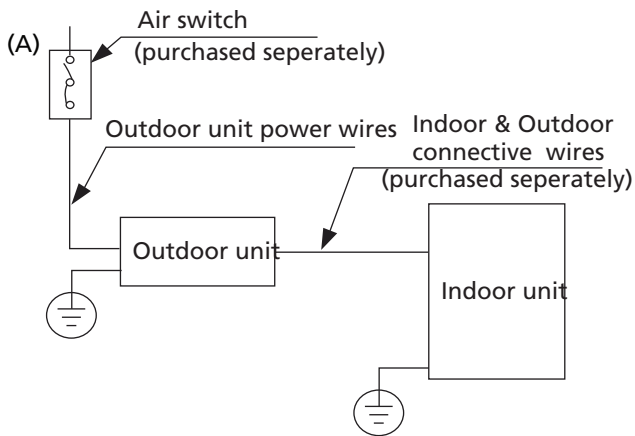

NOTE: The cographs are for explanation purpose only. Your machine may be slightly different. The actual shape shall prevail.

Outdoor Unit Wiring

⚠ WARNING

Before performing any electrical or wiring work, turn off the main power to the system.

1. Prepare the cable for connection
 - a. You must first choose the right cable size. Be sure to use H07RN-F cables.

Minimum Cross-Sectional Area of Power and Signal Cables (For reference)

Rated Current of Appliance (A)	Nominal Cross-Sectional Area (mm ²)
> 3 and ≤ 6	0.75
> 6 and ≤ 10	1
> 10 and ≤ 16	1.5
> 16 and ≤ 25	2.5
> 25 and ≤ 32	4
> 32 and ≤ 40	6

- b. Using wire strippers, strip the rubber jacket from both ends of the signal cable to reveal approximately 15cm (5.9") of wire.
- c. Strip the insulation from the ends.
- d. Using a wire crimper, crimp u-lugs on the ends.

NOTE: When connecting the wires, strictly follow the wiring diagram found inside the electrical box cover.

2. Remove the electric cover of the outdoor unit.
3. Connect the u-lugs to the terminals
Match the wire colors/labels with the labels on the terminal block, Firmly screw the u-lug of each wire to its corresponding terminal.
4. Clamp down the cable with the cable clamp.
5. Insulate unused wires with electrical tape.
Keep them away from any electrical or metal parts.
6. Reinstall the cover of the electric control box.

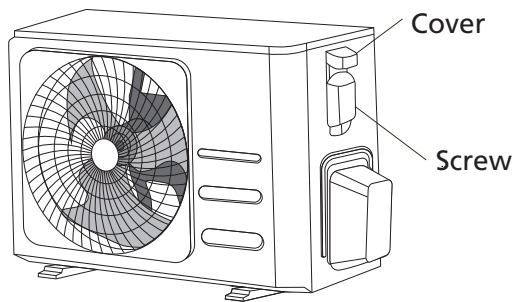

Indoor Unit Wiring

1. Prepare the cable for connection
 - a. Using wire strippers, strip the rubber jacket from both ends of the signal cable to reveal about 15cm (5.9") of the wire.
 - b. Strip the insulation from the ends of the wires.
 - c. Using a wire crimper, crimp the u-lugs to the ends of the wires.
2. Undo the screw on the cover of the electric control box and remove the cover.

3. Connect the u-lugs to the terminals.
Match the wire colors/labels with the labels on the terminal block, Firmly screw the u-lug of each wire to its corresponding terminal.
Refer to the Serial Number and Wiring Diagram located on the cover of the electric control box.

CAUTION

- While connecting the wires, please strictly follow the wiring diagram.
 - The refrigerant circuit can become very hot. Keep the interconnection cable away from the copper tube.
4. Clamp down the cable with the cable clamp.
The cable must not be loose or pull on the u-lugs.
 5. Reattach the electric box cover.

Air Evacuation

Preparations and Precautions

Air and foreign matter in the refrigerant circuit can cause abnormal rises in pressure, which can damage the air conditioner, reduce its efficiency, and cause injury. Use a vacuum pump and manifold gauge to evacuate the refrigerant circuit, removing any non-condensable gas and moisture from the system.

Evacuation should be performed upon initial installation and when unit is relocated.

BEFORE PERFORMING EVACUATION

- ☑ Check to make sure the connective pipes between the indoor and outdoor units are connected properly .
- ☑ Check to make sure all wiring is connected properly.

Evacuation Instructions

1. Connect the charge hose of the manifold gauge to service port on the outdoor unit's low pressure valve.
2. Connect another charge hose from the manifold gauge to the vacuum pump.
3. Open the Low Pressure side of the manifold gauge. Keep the High Pressure side closed.
4. Turn on the vacuum pump to evacuate the system.
5. Run the vacuum for at least 15 minutes, or until the Compound Meter reads -76cmHG (-10⁵ Pa).

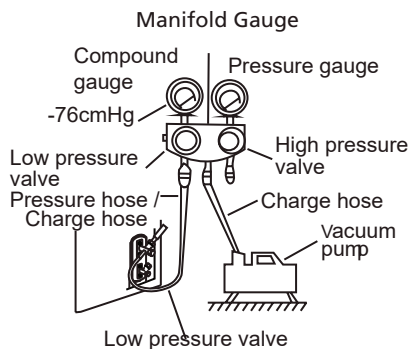

6. Close the Low Pressure side of the manifold gauge, and turn off the vacuum pump.

7. Wait for 5 minutes, then check that there has been no change in system pressure.
8. If there is a change in system pressure, refer to Gas Leak Check section for information on how to check for leaks. If there is no change in system pressure, unscrew the cap from the packed valve (high pressure valve).
9. Insert hexagonal wrench into the packed valve (high pressure valve) and open the valve by turning the wrench in a 1/4 counterclockwise turn. Listen for gas to exit the system, then close the valve after 5 seconds.
10. Watch the Pressure Gauge for one minute to make sure that there is no change in pressure. The Pressure Gauge should read slightly higher than atmospheric pressure.
11. Remove the charge hose from the service port.

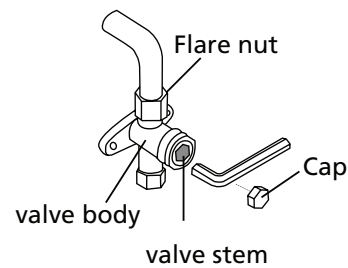

12. Using hexagonal wrench, fully open both the high pressure and low pressure valves.
13. Tighten valve caps on all three valves (service port, high pressure, low pressure) by hand. You may tighten it further using a torque wrench if needed.

! OPEN VALVE STEMS GENTLY

When opening valve stems, turn the hexagonal wrench until it hits against the stopper. Do not try to force the valve to open further.

Note on Adding Refrigerant

Some systems require additional charging depending on pipe lengths. The standard pipe length varies according to local regulations. For example, in North America, the standard pipe length is 7.5m (25'). In other areas, the standard pipe length is 5m (16'). The refrigerant should be charged from the service port on the outdoor unit's low pressure valve. The additional refrigerant to be charged can be calculated using the following formula:

Liquid Side Diameter

	φ6.35(1/4")	φ9.52(3/8")	φ12.7(1/2")
R22 (orifice tube in the indoor unit):	(Total pipe length - standard pipe length) x 30g (0.32oz)/m(ft)	(Total pipe length - standard pipe length) x 65g(0.69oz)/m(ft)	(Total pipe length - standard pipe length) x 115g(1.23oz)/m(ft)
R22 (orifice tube in the outdoor unit):	(Total pipe length - standard pipe length) x 15g(0.16oz)/m(ft)	(Total pipe length - standard pipe length) x 30(0.32oz)/m(ft)	(Total pipe length - standard pipe length) x 60g(0.64oz)/m(ft)
R410A: (orifice tube in the indoor unit):	(Total pipe length - standard pipe length) x 30g(0.32oz)/m(ft)	(Total pipe length - standard pipe length) x 65g(0.69oz)/m(ft)	(Total pipe length - standard pipe length) x 115g(1.23oz)/m(ft)
R410A: (orifice tube in the outdoor unit):	(Total pipe length - standard pipe length) x 15g(0.16oz)/m(ft)	(Total pipe length - standard pipe length) x 30g(0.32oz)/m(ft)	(Total pipe length - standard pipe length) x 65g(0.69oz)/m(ft)
R32 :	(Total pipe length - standard pipe length) x 12g(0.13oz)/m(ft)	(Total pipe length - standard pipe length) x 24g(0.26oz)/m(ft)	(Total pipe length - standard pipe length) x 40g(0.42oz)/m(ft)

 **CAUTION** DO NOT mix refrigerant types.

Test Run

Before Test Run

A test run must be performed after the entire system has been completely installed. Confirm the following points before performing the test:

- a) Indoor and outdoor units are properly installed.
- b) Piping and wiring are properly connected.
- c) No obstacles near the inlet and outlet of the unit that might cause poor performance or product malfunction.
- d) Refrigeration system does not leak.
- e) Drainage system is unimpeded and draining to a safe location.
- f) Heating insulation is properly installed.
- g) Grounding wires are properly connected.
- h) Length of the piping and additional refrigerant stow capacity have been recorded.
- i) Power voltage is the correct voltage for the air conditioner.

CAUTION

Failure to perform the test run may result in unit damage, property damage, or personal injury.

Test Run Instructions

1. Open both the liquid and gas stop valves.
2. Turn on the main power switch and allow the unit to warm up.
3. Set the air conditioner to COOL mode.
4. For the Indoor Unit
 - a. Ensure the remote control and its buttons work properly.
 - b. Ensure the louvers move properly and can be changed using the remote control.
 - c. Double check to see if the room temperature is being registered correctly.
 - d. Ensure the indicators on the remote control and the display panel on the indoor unit work properly.
 - e. Ensure the manual buttons on the indoor unit works properly.

- f. Check to see that the drainage system is unimpeded and draining smoothly.
 - g. Ensure there is no vibration or abnormal noise during operation.
5. For the Outdoor Unit
 - a. Check to see if the refrigeration system is leaking.
 - b. Make sure there is no vibration or abnormal noise during operation.
 - c. Ensure the wind, noise, and water generated by the unit do not disturb your neighbors or pose a safety hazard.
 6. Drainage Test
 - a. Ensure the drainpipe flows smoothly. New buildings should perform this test before finishing the ceiling.
 - b. Remove the test cover. Add 2,000ml of water to the tank through the attached tube.
 - c. Turn on the main power switch and run the air conditioner in COOL mode.
 - d. Listen to the sound of the drain pump to see if it makes any unusual noises.
 - e. Check to see that the water is discharged. It may take up to one minute before the unit begins to drain depending on the drainpipe.
 - f. Make sure that there are no leaks in any of the piping.
 - g. Stop the air conditioner. Turn off the main power switch and reinstall the test cover.

NOTE: If malfunction occurs, or the unit does not operate according to your expectations, please refer to the Troubleshooting section of the Owner's Manual before calling for customer service.

Packing and unpacking the unit

Instructions for packing/unpacking the unit:

Unpacking:

Indoor unit:

1. Cut the sealing tape on the carton with a knife.
2. Take off the carton.
3. Remove the upper packaging foam.
4. Untie the packaging bag.
5. Take out the indoor unit.

Outdoor Unit

1. Cut the packing belt.
2. Take the unit out of the carton.
3. Remove the foam from the unit.
4. Remove the packaging bag from the unit.

Packing:

Indoor unit:

1. Put the indoor unit on the lower packaging foam.
2. Put the packing bag on the indoor unit.
2. Attach the upper packaging foam to the unit.
3. Put the carton on the unit.
4. Seal it with the tape.
5. Using the packing belt if necessary.

Outdoor unit:

1. Put the outdoor unit into the packing bag.
2. Put the bottom foam into the box.
3. Put the unit into the carton, then put the upper packaging foam on the unit.
4. Close the carton and seal it with the tape.
5. Using the packing belt if necessary.

NOTE: Please keep all packaging items if you may need in the future.

The design and specifications are subject to change without prior notice for product improvement. Consult with the sales agency or manufacturer for details.
Any updates to the manual will be uploaded to the service website, please check for the latest version.

Importer:
ROMSTAL IMEX SRL
Importer Address:
Vitan-Barzesti Avenue No 11A, 042122, Bucharest

CF004UI-GA
16122200A24956