



PERFORMANCE CURVES

07/04/26

Page 2 / 3

DAB PUMPS S.p.A.
Via Marco Polo, 14 - 35035 Mestrino (PD), Italy
Tel. +39 049 5125000 - Fax +39 049 5125950
www.dabpumps.com

Receiver

Company
Reference
Address
Phone
Fax
E-mail

KLP 40-1800/BQQE/0,7 3x230/400 50 IE3

Curve tolerance according to ISO 9906

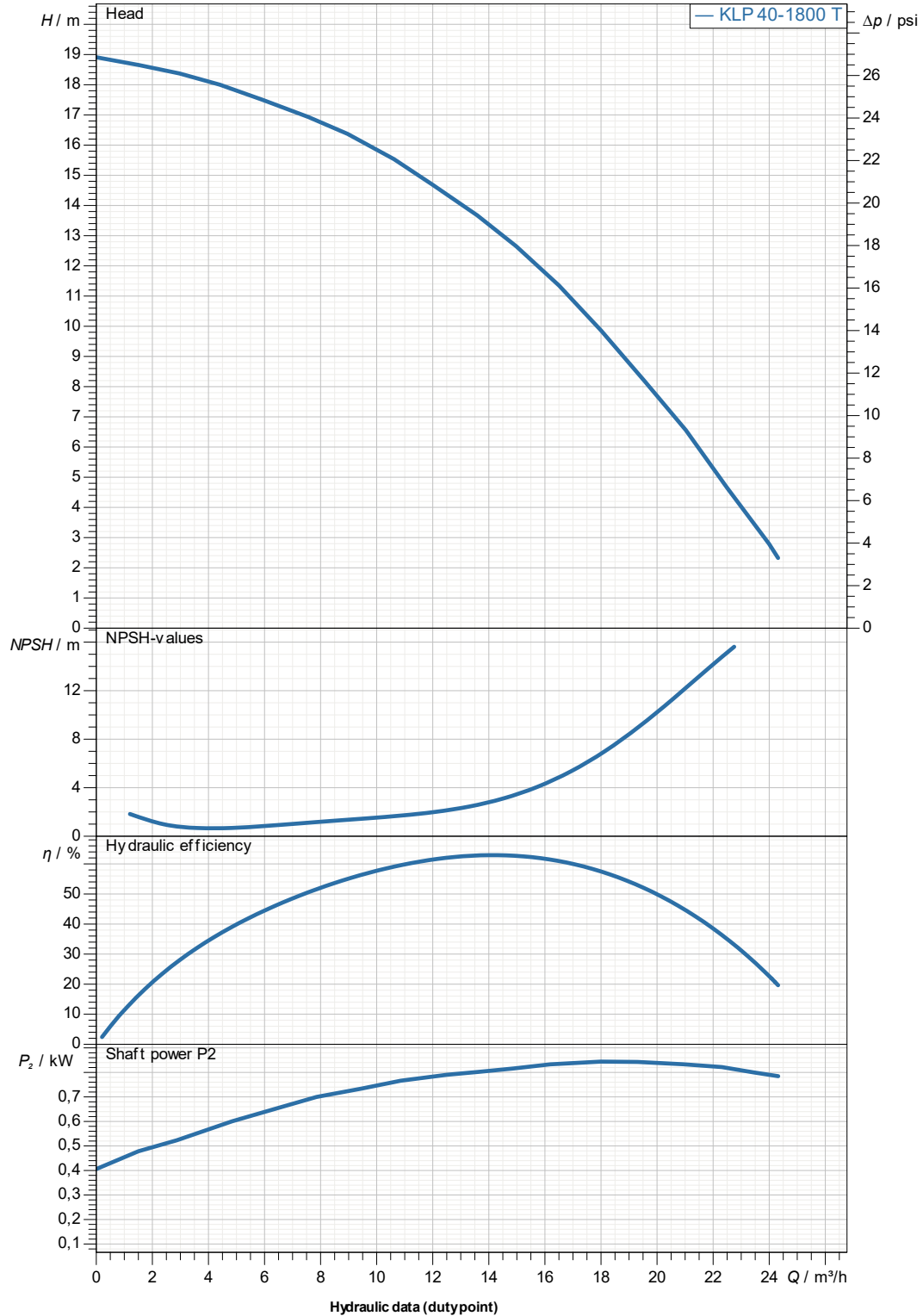

Suction side :
DN 40
145 psi

Discharge side :
DN 40
145 psi

Flow :

Head :

Rated speed :
2.940 1/min

Project

Project ID

Created by

Created on

07/04/26

Receiver

Company
Reference
Address
Phone
Fax
E-mail

KLP 40-1800/BQQE/0,7 3x230/400 50 IE3

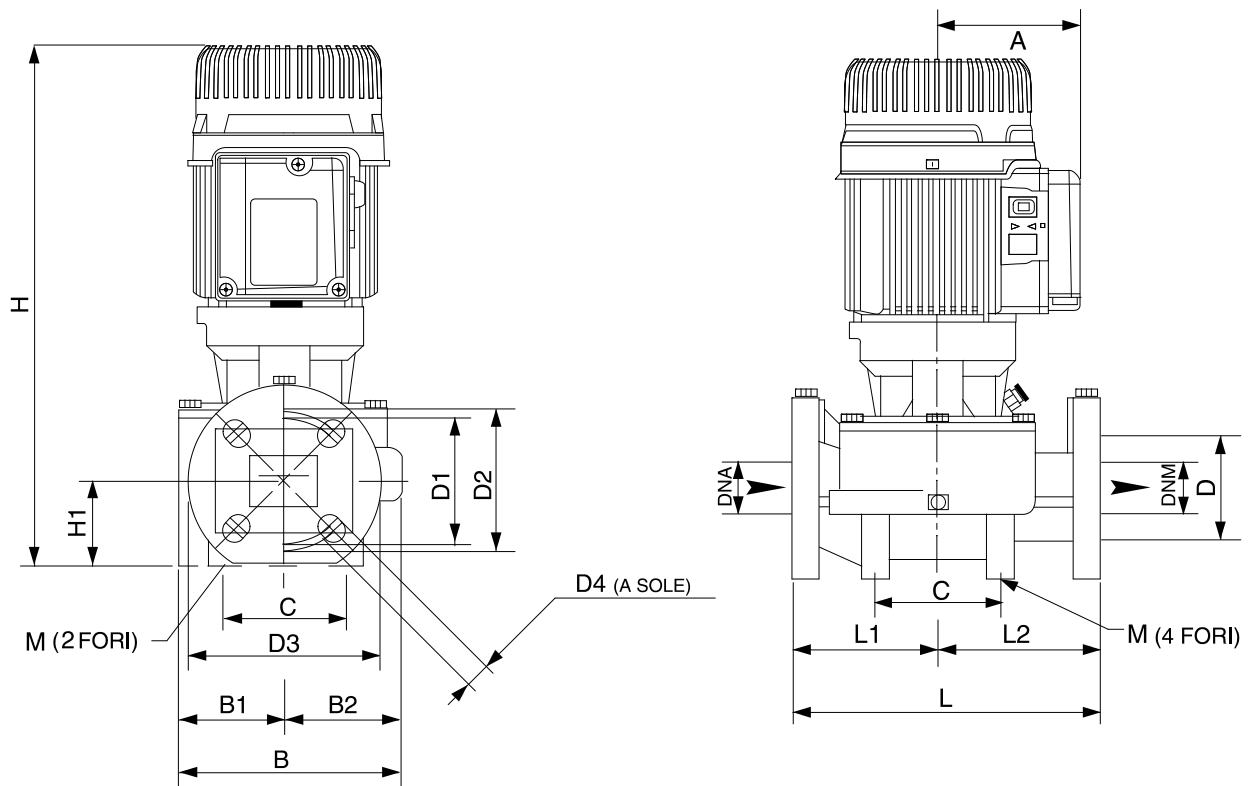

Dimensions in mm

Pump connection

1	A	110	DNM	40	Suction DN 40 145 psi Discharge DN 40 145 psi
2	B	179	H	395	
3	B1	82	H1	66	
4	B2	97	L	250	
5	C	100	L1	125	
6	D	80	L2	125	
7	D1	100	M	2 fori 10	
8	D2	110			
9	D3	150			
10	D4	4 asole 18x23			
11	DNA	40			

Project	Project ID	Created by	Created on 07/04/26
---------	------------	------------	-------------------------------